

# NH KNIFE-BLADE

FUSE LINKS & FUSE BASES

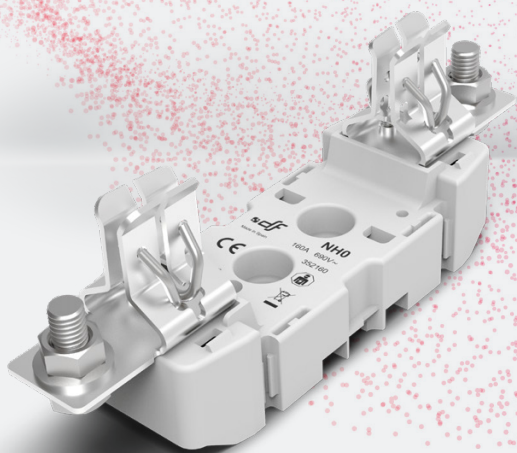

## NH ST 690V

bases for NH fuse links



# PROTECTING THE WORLD

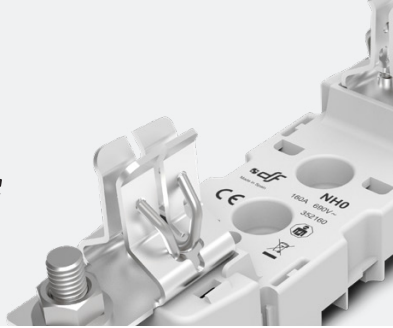

RATED CURRENT

160A

RATED VOLTAGE

690V AC

MAXIMUM POWER DISSIPATION

25W

PROTECTION INDEX

IP00

IP20

STANDARDS

IEC/EN 60269-1

IEC/EN 60269-2

DIN 43620

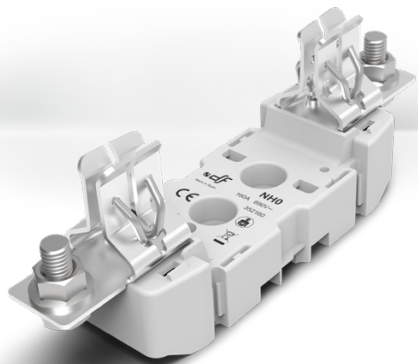

## ST fuse bases for NH Knife-blade fuse links

Manufactured with a high quality materials

- Silver plated copper contacts.
- Plastic materials with high temperature resistance and self-extinguishable.
- All the materials are according to the European Directive RoHS (Restriction of the use of certain hazardous substances in electrical material).



For mounting on DIN/EN rail or with screw fixing.

Single-phase or three-pole type.

Connection by screws, fixed nut or clamps.

Contacts with double spring in order to obtain an optimum operation.

Wide range of accessories (contact covers, fuse link covers, partition walls) that enables IP20 protection index.

Multi-pole units can be made with connection accessories.

Manufactured according IEC, EN and DIN standards.

## Accessories

REFERENCE	DESCRIPTION	PACKING Uni./BOX
<b>326160</b>	PARTITION WALL DIRECTLY FIXED TO THE BODY	2
<b>325160</b>	SEPARATOR MULTIPOLE UNITS SEPARATOR	2
<b>325001</b>	TERMINAL COVER	6
<b>325015</b>	FUSE LINKS COVER	3
<b>325036</b>	IP20 PROTECTION KIT	1
<b>341160</b>	NEUTRAL LINK	3
<b>357160</b>	MICROSWITCH REPLACEMENT	1
<b>357010</b>	MICROSWITCH	1/12
<b>340001</b>	FUSE PULLER	1

### TERMINALS

	CROSS SECTION (mm <sup>2</sup> )	CABLE	
<b>343160</b>	95/10	1	3
<b>344160</b>	95/10	2	3

## Range

REFERENCE	POLES	FIXING	CONNECTION	PACKING Uni./BOX
<b>354160</b>	1P	SCREW	SCREW	3
<b>352160</b>	1P	DIN RAIL/SCREW	SCREW	3
<b>355160</b>	3P	SCREW	SCREW	1
<b>353160</b>	3P	DIN RAIL/SCREW	SCREW	1
<b>356160*</b>	1P	DIN RAIL/SCREW	SCREW	1

\* with microswitch

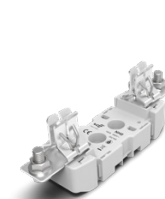

352160

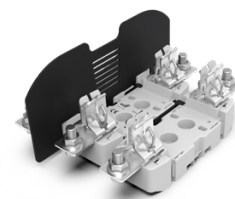

353160



356160

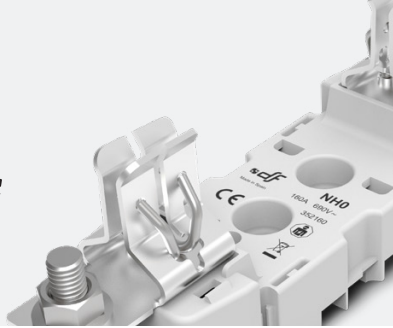

## Technical data

Rated current	160A	
Rated voltage	690V AC 750V DC	
Rated power dissipation	25W	
Protection index	IP00 / IP20	
Ambient temperature of service	-20°C ... 80°C	
Storage temperature	-40°C ... 80°C	
Correction of the admissible current in function of the temperature	20° C	1
	30° C	0,95
	40° C	0,90
	50° C	0,80
	60° C	0,70
	70° C	0,60
	80° C	0,50



**DO NOT OPERATE UNDER LOAD**

## Standards

IEC/EN 60269-1  
IEC/EN 60269-2  
DIN 43620

## Application characteristics

Mounting	DIN/EN Standard Rail DIN 46277/1-3 (EN50022) Screws
Connecting wire	M8
Maximum tightening torque on terminals	10 Nm
Maximum tightening torque fuse holder fixation with screws	5 Nm
Multipolar assembly	► FIG. 1

## Materials

Contacts	Silver plated copper
Body	Thermoplastic, high resistance to temperature Flammability: (UL94) V0 Glow wire test: (IEC-60695) 960°C
Partition walls	Thermoplastic, high resistance to temperature Flammability: (UL94) V0 Glow wire test: (IEC-60695) 960°C
Separators	Thermoplastic, high resistance to temperature Flammability: (UL94) V0 Glow wire test: (IEC-60695) 960°C
Terminal covers	Thermoplastic, high resistance to temperature Flammability: (UL94) V0 Glow wire test: (IEC-60695) 960°C
Fuse links covers	Thermoplastic, high resistance to temperature Flammability: (UL94) V2 Glow wire test: (IEC-60695) 850°C
Accessory terminals	Tin plated brass Zinc plated steel screws

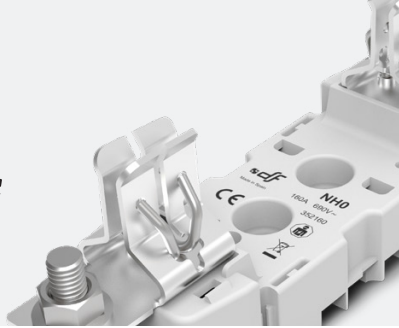

## Dimensions

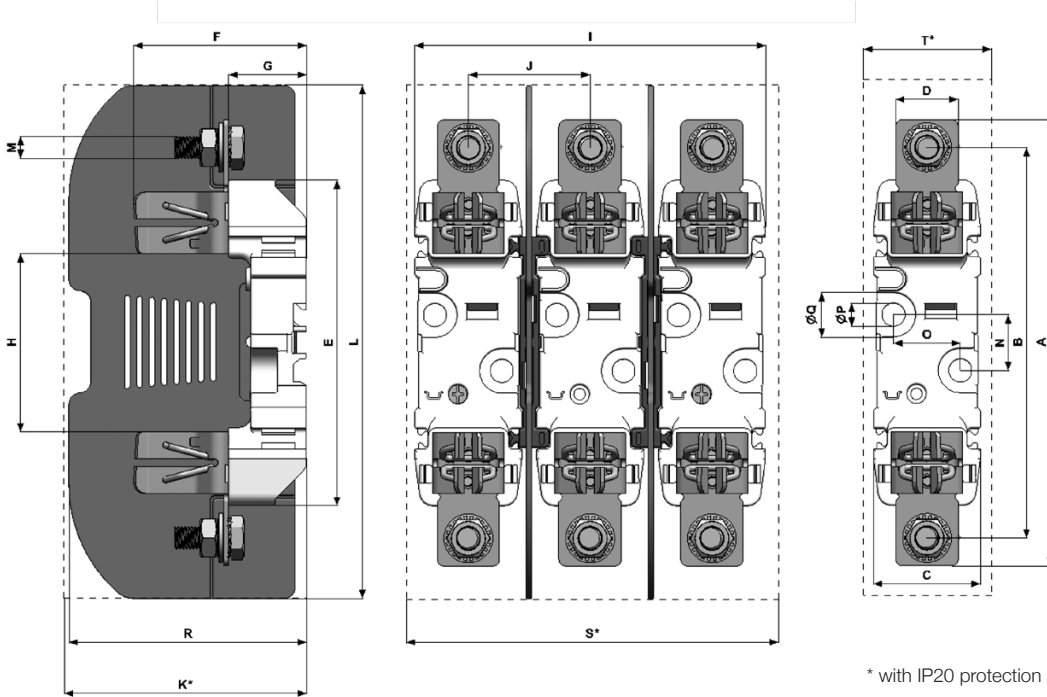

A	B	C	D	E	F	G	H	I	J	K	L	M	N	O	P	Q	R	S	T
170	150	47	24	122	63	29	74	144	48,5	91,5	185	M8	25	-	7,5	15	92	144	47

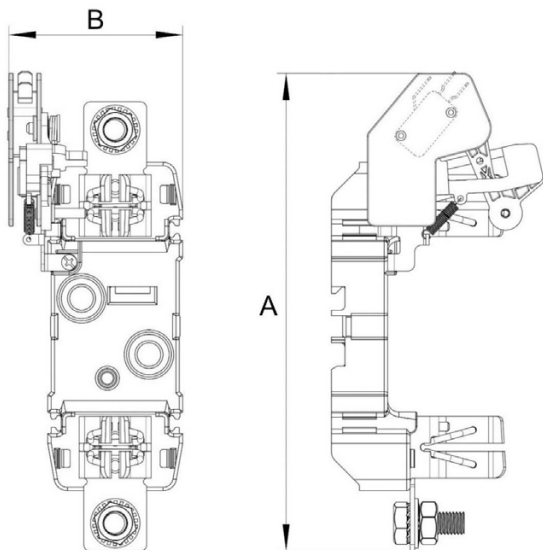

<b>A</b>	<b>B</b>
193	65,5

## Weight

<b>1P</b>	180gr
<b>3P</b>	620gr
<b>1P with microswitch</b>	250gr

Weight without packing

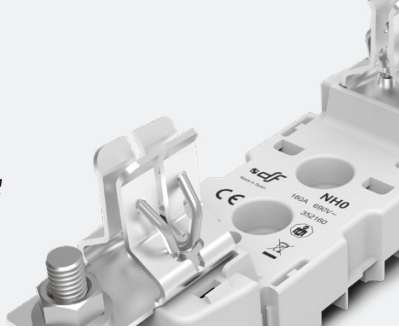

## Accessories assembly

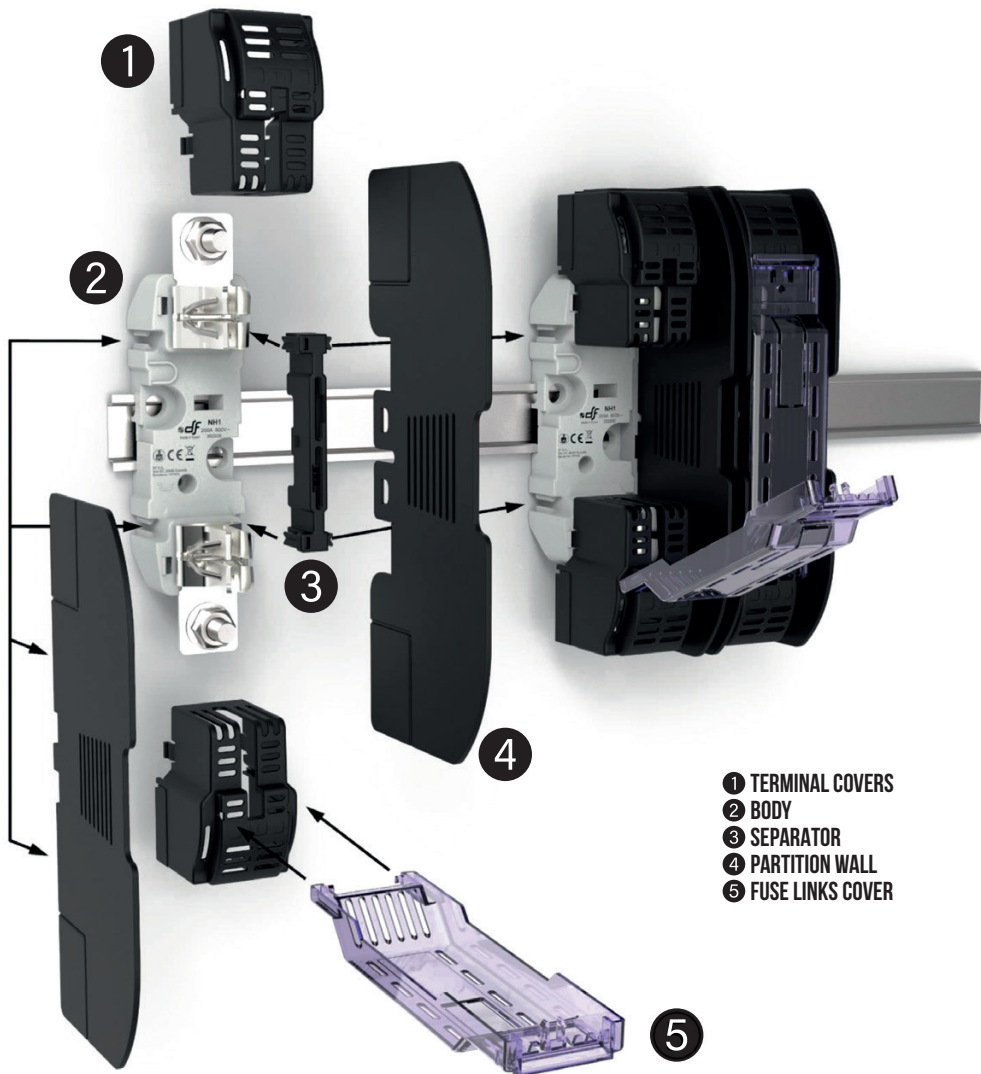

- 1 TERMINAL COVERS
- 2 BODY
- 3 SEPARATOR
- 4 PARTITION WALL
- 5 FUSE LINKS COVER

The fuse holder allows using simultaneously a microswitch for NH fuse links and IP20 protection accessories



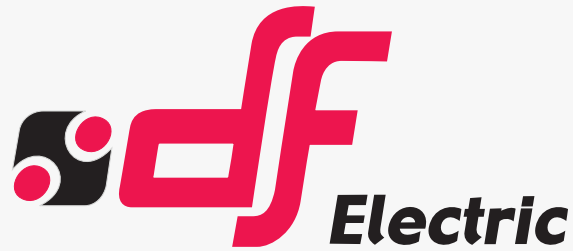

# PROTECTING THE WORLD

### HEAD OFFICE AND FACTORY

SILICI, 67-69  
08940 CORNELLA DE LLOBREGAT  
BARCELONA · SPAIN  
Tel. +34 93 377 85 85  
Fax +34 93 377 82 82

### INTERNATIONAL SALES

Tel. +34 93 475 08 64  
Fax +34 93 480 07 75  
export@dfelectric.es

### NATIONAL SALES

Tel. 93 475 08 64  
Fax 93 480 07 76  
comercial@dfelectric.es

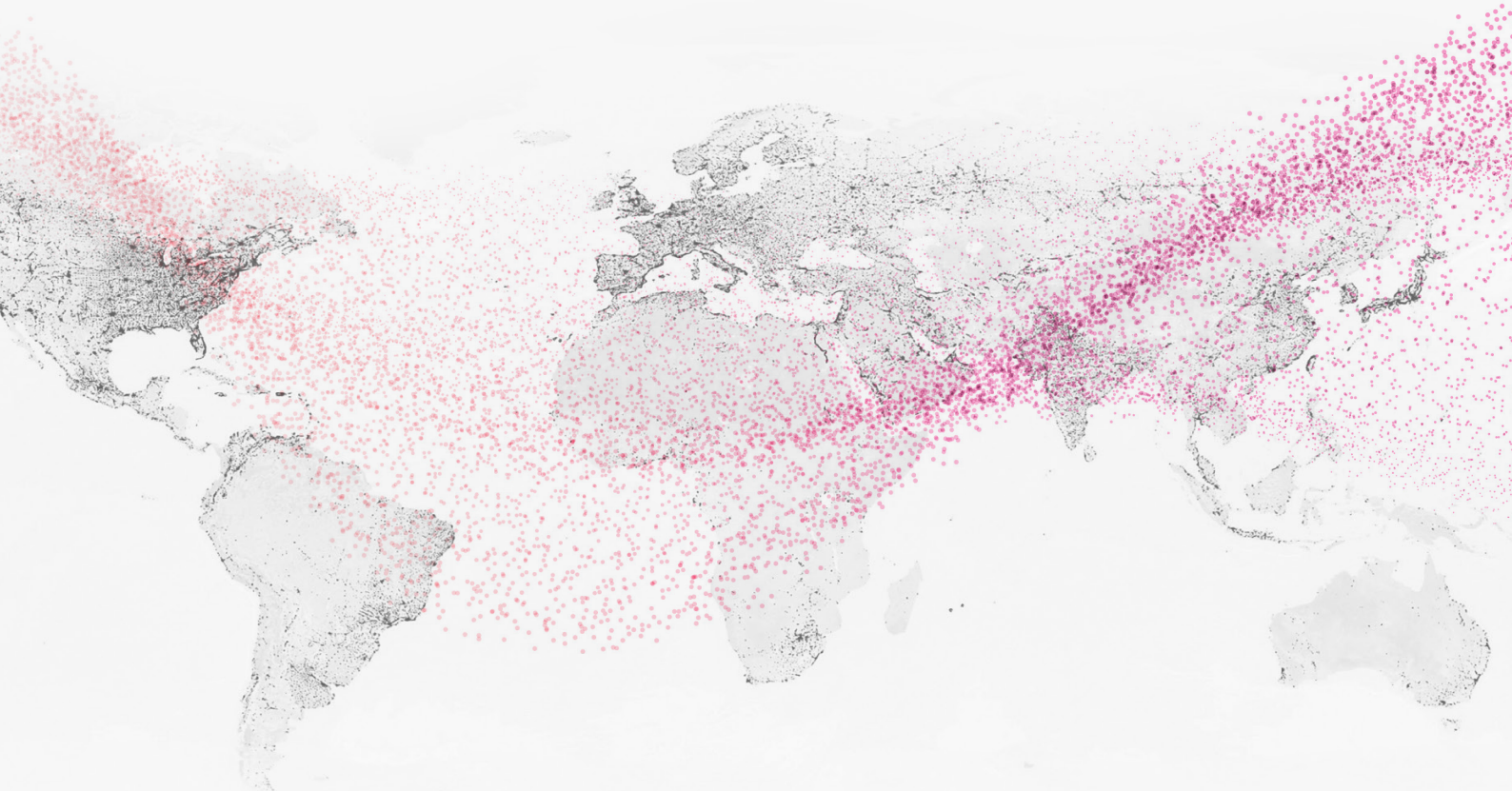

dfelectric.es



According to the waste of electrical and electronic equipment directive, electrical material should not be part of the usual waste. This symbol alerts users that these products should be recycled according to local environmental waste disposal regulations.



The "electro technical expert" logo marked on the products included in this data sheet indicates that the installation of these products must be carried out by expert personnel with specialized knowledge.



To prevent electrical hazards, carry out the installation without voltage.



**Safety notice**  
Please capture the following QR code and read our safety notice carefully before installing our products.



The data reflected in this technical record are subject to the correct installation of the product in accordance with manufacturer's instructions, relevant installation standards and professional practices, maintained and used in applications for which they were made.

The products described in this document have been designed, developed and tested in accordance with specific standard. They are considered components that are integrated as part of installation, machine or equipment. The correct general operation of the referred product is responsibility of the manufacturer of the installation, machine or equipment.

DF ELECTRIC cannot guarantee the characteristics of an installation, machine or equipment that has been designed by a third party. Once a product has been selected, the user must verify that it is appropriate for its application, through the verifications and/or tests that it deems appropriate.

DF ELECTRIC retains the right to change the dimensions, specifications, materials or design of its products at any time with or without notice.

©2022 DF Electric. All rights reserved