

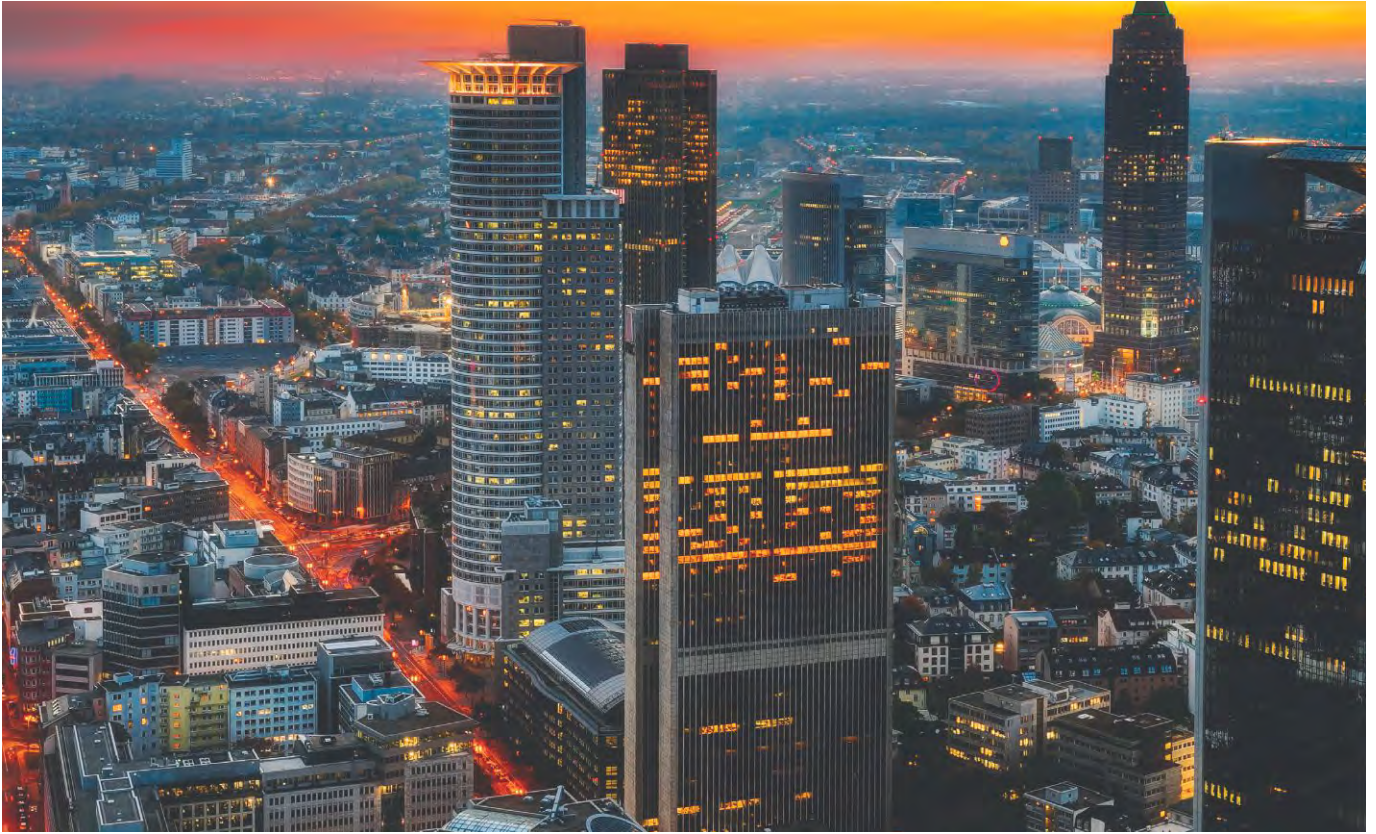

IN THE LINE OF POWER



Catalog  
Fuse-Links



## The Core of Safe Power Distribution

Grown from our traditional core competence, we at EFEN offer a comprehensive range of fuse-links according to IEC/DIN standards for low-voltage and medium-voltage applications. Our innovative high-tech products protect people and investments and ensure maximum availability.



### NH Fuse-Links

Complete range of NH Fuse-links for cable, line, transformer and semiconductor protection. In addition to standard applications, the EFEN range includes various solutions for special applications. NH fuse-links by EFEN comply with national and international standards and regulations such as IEC 60269 and VDE 0636.

Product overview page 10



### DC Fuse-Links 10 x 38

EFEN DC fuse-links 10 x 38 have been developed especially for direct-current supplies. They combine high energy density with a compact, space-saving design.

Product overview page 70



### D0 Fuse-Links

The D0 fuse-links offer protection within the smallest space and, thanks to state-of-the-art distribution components, perfectly integrate into future systems.

Product overview page 60



### HV Fuse-Links

EFEN's general-purpose and back-up fuse-links are a reliable safety interface for transformers, capacitors and high-voltage motors. The range comprises types for indoor, outdoor and oil-submerged applications and is nationally and internationally approved.

Product overview page 74

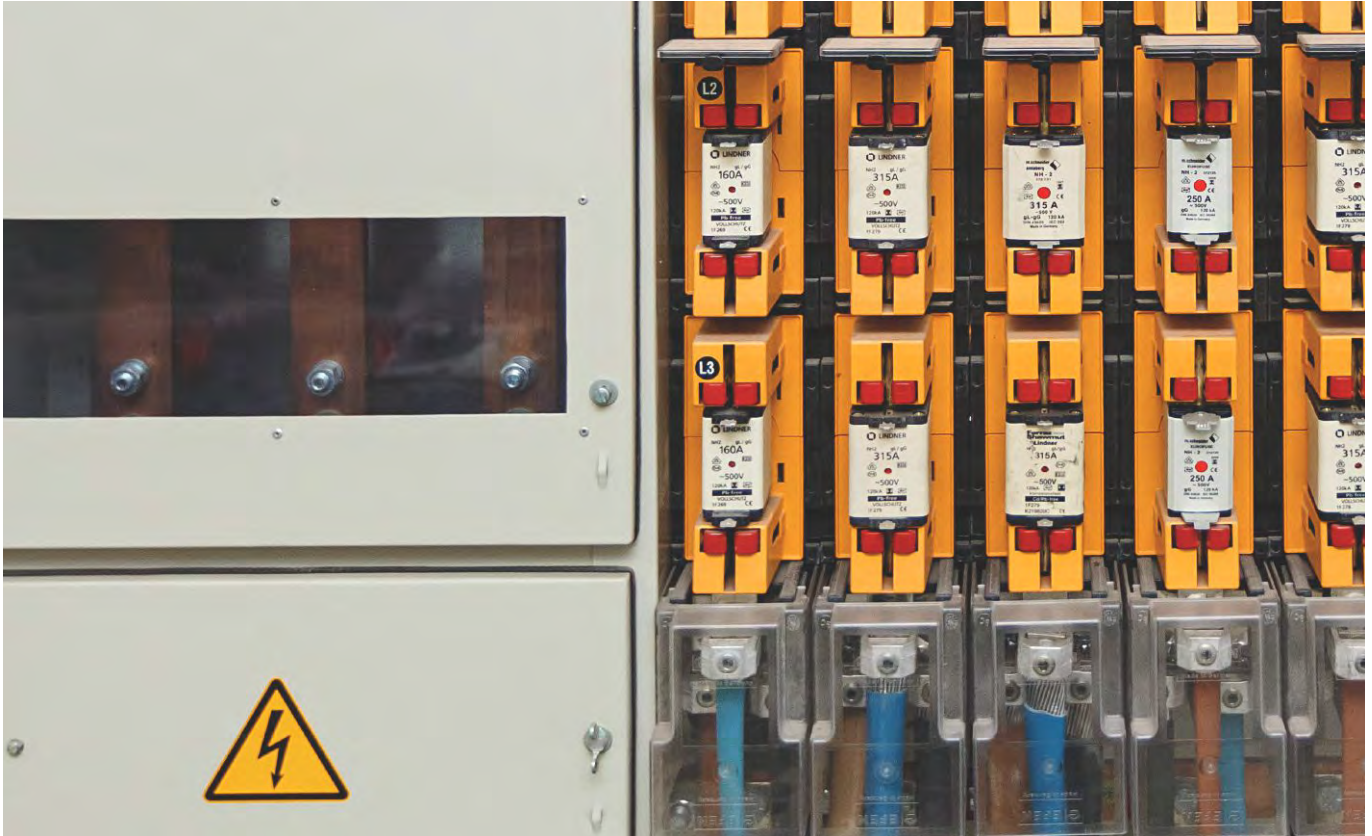

## NH Fuse-Links

Grow from our traditional core competence, we at EFEN offer a comprehensive range of Fuse-Links according to IEC/DIN standards for low-voltage and medium-voltage applications. Innovative high-tech products protect people and investments and ensure maximum availability.

### System

The wide range of state-of-the-art NH fuse-links grew from EFEN's traditional core competence, taking it to a leading position in the market, with high technical standards and ensuring a consistently high quality. The EFEN product range offers a wide variety of solutions for virtually any application.

### Features

EFEN NH fuse-links comply with national and international standards and regulations such as DIN, VDE and IEC. The fuse-links are available with insulated and with uninsulated gripping lugs. A full range of accessories complements the product range.



**NH Fuse-Links**

NH Fuse-Links AC 400 up to 690 V gG and gL	page 14
NH Fuse-Links AC 500 V gR	page 25
NH Fuse-Links AC 400 V gTr	page 28
NH Fuse-Links AC 1000 V gB/aM	page 29
NH Fuse-Links AC 1500 V TF	page 30
NH Fuse-Links DC 80 V	page 52
NH Fuse-Links DC 550 V	page 53
NH Fuse-Links DC 1000 V	page 54
NH Accessories for Fuse-Links	page 58
Technical data	page 32

**NH Fuse-Link 400 V**  
with twin indicator



**NH Fuse-Links**  
for industry-specific applications,  
e.g. mining



**gTr Fuse-Links**  
for transformer protection



**NH Fuse-Links**  
up to 1500 V AC



**gR NH Fuse-Links**  
for semiconductor protection



**Special Fuse-Links**  
for DC applications



## NH Fuse-Links 400 V gG

- Rated voltage: AC 400 V
- Utilization category: gG acc. to VDE 0636-2 and VDE 0636-1
- IEC 60269-2 and IEC 60269-1
- Breaking capacity: 100 kA

► Technical data, page 32



35404-1600

### NH Fuse-Links for cable and line protection, 400 V AC gG

#### Features:

- Twin indicator (size 3, 500 A and 630 A with center indicator)
- Non-insulated metal gripping lug
- Copper fuse element

Designation	Size	Amps	PU	Product designation	Order no.
NH-SI 000 2A GG AC400V AK	000	2	3	NH-SI 000 2A GG AC400V AK	35401-0020
NH-SI 000 4A GG AC400V AK	000	4	3	NH-SI 000 4A GG AC400V AK	35401-0040
NH-SI 000 6A GG AC400V AK	000	6	3	NH-SI 000 6A GG AC400V AK	35401-0060
NH-SI 000 10A GG AC400V AK	000	10	3	NH-SI 000 10A GG AC400V AK	35401-0100
NH-SI 000 16A GG AC400V AK	000	16	3	NH-SI 000 16A GG AC400V AK	35401-0160
NH-SI 000 20A GG AC400V AK	000	20	3	NH-SI 000 20A GG AC400V AK	35401-0200
NH-SI 000 25A GG AC400V AK	000	25	3	NH-SI 000 25A GG AC400V AK	35401-0250
NH-SI 000 32A GG AC400V AK	000	32	3	NH-SI 000 32A GG AC400V AK	35401-0320
NH-SI 000 35A GG AC400V AK	000	35	3	NH-SI 000 35A GG AC400V AK	35401-0350
NH-SI 000 50A GG AC400V AK	000	50	3	NH-SI 000 50A GG AC400V AK	35401-0500
NH-SI 000 63A GG AC400V AK	000	63	3	NH-SI 000 63A GG AC400V AK	35401-0630
NH-SI 000 80A GG AC400V AK	000	80	3	NH-SI 000 80A GG AC400V AK	35401-0800
NH-SI 000 100A GG AC400V AK	000	100	3	NH-SI 000 100A GG AC400V AK	35401-1000
NH-SI 00 63A GG AC400V AK	00	63	3	NH-SI 00 63A GG AC400V AK	35402-0630
NH-SI 00 80A GG AC400V AK	00	80	3	NH-SI 00 80A GG AC400V AK	35402-0800
NH-SI 00 100A GG AC400V AK	00	100	3	NH-SI 00 100A GG AC400V AK	35402-1000
NH-SI 00 125A GG AC400V AK	00	125	3	NH-SI 00 125A GG AC400V AK	35402-1250
NH-SI 00 160A GG AC400V AK	00	160	3	NH-SI 00 160A GG AC400V AK	35402-1600
NH-SI 1/16A GG AC400V AK	1	16	3	NH-SI 1/ 16A GG AC400V AK	35403-0160
NH-SI 1/20A GG AC400V AK	1	20	3	NH-SI 1/ 20A GG AC400V AK	35403-0200
NH-SI 1/25A GG AC400V AK	1	25	3	NH-SI 1/ 25A GG AC400V AK	35403-0250
NH-SI 1/32A GG AC400V AK	1	32	3	NH-SI 1/ 32A GG AC400V AK	35403-0320
NH-SI 1/35A GG AC400V AK	1	35	3	NH-SI 1/ 35A GG AC400V AK	35403-0350
NH-SI 1/40A GG AC400V AK	1	40	3	NH-SI 1/ 40A GG AC400V AK	35403-0400
NH-SI 1/50A GG AC400V AK	1	50	3	NH-SI 1/ 50A GG AC400V AK	35403-0500
NH-SI 1/63A GG AC400V AK	1	63	3	NH-SI 1/ 63A GG AC400V AK	35403-0630
NH-SI 1/80A GG AC400V AK	1	80	3	NH-SI 1/ 80A GG AC400V AK	35403-0800
NH-SI 1/100A GG AC400V AK	1	100	3	NH-SI 1/ 100A GG AC400V AK	35403-1000
NH-SI 1 125A GG AC400V AK	1	125	3	NH-SI 1 125A GG AC400V AK	35403-1250
NH-SI 1 160A GG AC400V AK	1	160	3	NH-SI 1 160A GG AC400V AK	35403-1600
NH-SI 1 200A GG AC400V AK	1	200	3	NH-SI 1 200A GG AC400V AK	35403-2000
NH-SI 1 224A GG AC400V AK	1	224	3	NH-SI 1 224A GG AC400V AK	35403-2240
NH-SI 1 250A GG AC400V AK	1	250	3	NH-SI 1 250A GG AC400V AK	35403-2500
NH-SI 2/35A GG AC400V AK	2	35	3	NH-SI 2/ 35A GG AC400V AK	35404-0350
NH-SI 2/50A GG AC400V AK	2	50	3	NH-SI 2/ 50A GG AC400V AK	35404-0500
NH-SI 2/63A GG AC400V AK	2	63	3	NH-SI 2/ 63A GG AC400V AK	35404-0630
NH-SI 2/80A GG AC400V AK	2	80	3	NH-SI 2/ 80A GG AC400V AK	35404-0800
NH-SI 2/100A GG AC400V AK	2	100	3	NH-SI 2/ 100A GG AC400V AK	35404-1000
NH-SI 2/125A GG AC400V AK	2	125	3	NH-SI 2/ 125A GG AC400V AK	35404-1250
NH-SI 2/160A GG AC400V AK	2	160	3	NH-SI 2/ 160A GG AC400V AK	35404-1600
NH-SI 2/200A GG AC400V AK	2	200	3	NH-SI 2/ 200A GG AC400V AK	35404-2000
NH-SI 2/224A GG AC400V AK	2	224	3	NH-SI 2/ 224A GG AC400V AK	35404-2240
NH-SI 2/250A GG AC400V AK	2	250	3	NH-SI 2/ 250A GG AC400V AK	35404-2500
NH-SI 2 315A GG AC400V AK	2	315	3	NH-SI 2 315A GG AC400V AK	35404-3150
NH-SI 2 355A GG AC400V AK	2	355	3	NH-SI 2 355A GG AC400V AK	35404-3550
NH-SI 2 400A GG AC400V AK	2	400	3	NH-SI 2 400A GG AC400V AK	35404-4000
NH-SI 3/250A GG AC400V AK	3	250	1	NH-SI 3/ 250A GG AC400V AK	35405-2500
NH-SI 3/300A GG AC400V AK	3	300	1	NH-SI 3/ 300A GG AC400V AK	35405-3000
NH-SI 3/315A GG AC400V AK	3	315	1	NH-SI 3/ 315A GG AC400V AK	35405-3150
NH-SI 3/400A GG AC400V AK	3	400	1	NH-SI 3/ 400A GG AC400V AK	35405-4000
NH-SI 3 500A GG AC400V MA	3	500	1	NH-SI 3 500A GG AC400V Ma	35405-5000
NH-SI 3 630A GG AC400V MA	3	630	1	NH-SI 3 630A GG AC400V Ma	35405-6300

# NH Fuse-Links 400V gG

- Rated voltage: AC 400 V
- Utilization category: gG acc. to VDE 0636-2 and VDE 0636-1
- IEC 60269-2 and IEC 60269-1
- Breaking capacity: 100kA

► Technical data, page 32



35407-1600

## NH Fuse-Links for cable and line protection, 400 V AC gG

### Features:

- Twin indicator
- Insulated metal gripping lug
- Copper fuse element

Designation	Size	Amps	PU	Product designation	Order no.
NH-SI 000 2A GG AC400V LI AK	000	2	3	NH-SI 000 2A GG AC400V LI AK	<b>35406-0020</b>
NH-SI 000 4A GG AC400V LI AK	000	4	3	NH-SI 000 4A GG AC400V LI AK	<b>35406-0040</b>
NH-SI 000 6A GG AC400V LI AK	000	6	3	NH-SI 000 6A GG AC400V LI AK	<b>35406-0060</b>
NH-SI 000 10A GG AC400V LI AK	000	10	3	NH-SI 000 10A GG AC400V LI AK	<b>35406-0100</b>
NH-SI 000 16A GG AC400V LI AK	000	16	3	NH-SI 000 16A GG AC400V LI AK	<b>35406-0160</b>
NH-SI 000 20A GG AC400V LI AK	000	20	3	NH-SI 000 20A GG AC400V LI AK	<b>35406-0200</b>
NH-SI 000 25A GG AC400V LI AK	000	25	3	NH-SI 000 25A GG AC400V LI AK	<b>35406-0250</b>
NH-SI 000 32A GG AC400V LI AK	000	32	3	NH-SI 000 32A GG AC400V LI AK	<b>35406-0320</b>
NH-SI 000 35A GG AC400V LI AK	000	35	3	NH-SI 000 35A GG AC400V LI AK	<b>35406-0350</b>
NH-SI 000 40A GG AC400V LI AK	000	40	3	NH-SI 000 40A GG AC400V LI AK	<b>35406-0400</b>
NH-SI 000 50A GG AC400V LI AK	000	50	3	NH-SI 000 50A GG AC400V LI AK	<b>35406-0500</b>
NH-SI 000 63A GG AC400V LI AK	000	63	3	NH-SI 000 63A GG AC400V LI AK	<b>35406-0630</b>
NH-SI 000 80A GG AC400V LI AK	000	80	3	NH-SI 000 80A GG AC400V LI AK	<b>35406-0800</b>
NH-SI 000 100A GG AC400V LI AK	000	100	3	NH-SI 000 100A GG AC400V LI AK	<b>35406-1000</b>
NH-SI 00 63A GG AC400V LI AK	00	63	3	NH-SI 00 63A GG AC400V LI AK	<b>35407-0630</b>
NH-SI 00 80A GG AC400V LI AK	00	80	3	NH-SI 00 80A GG AC400V LI AK	<b>35407-0800</b>
NH-SI 00 100A GG AC400V LI AK	00	100	3	NH-SI 00 100A GG AC400V LI AK	<b>35407-1000</b>
NH-SI 00 125A GG AC400V LI AK	00	125	3	NH-SI 00 125A GG AC400V LI AK	<b>35407-1250</b>
NH-SI 00 160A GG AC400V LI AK	00	160	3	NH-SI 00 160A GG AC400V LI AK	<b>35407-1600</b>
NH-SI 1/ 16A GG AC400V LI AK	1	16	3	NH-SI 1/ 16A GG AC400V LI AK	<b>35408-0160</b>
NH-SI 1/ 20A GG AC400V LI AK	1	20	3	NH-SI 1/ 20A GG AC400V LI AK	<b>35408-0200</b>
NH-SI 1/ 25A GG AC400V LI AK	1	25	3	NH-SI 1/ 25A GG AC400V LI AK	<b>35408-0250</b>
NH-SI 1/ 32A GG AC400V LI AK	1	32	3	NH-SI 1/ 32A GG AC400V LI AK	<b>35408-0320</b>
NH-SI 1/ 35A GG AC400V LI AK	1	35	3	NH-SI 1/ 35A GG AC400V LI AK	<b>35408-0350</b>
NH-SI 1/ 40A GG AC400V LI AK	1	40	3	NH-SI 1/ 40A GG AC400V LI AK	<b>35408-0400</b>
NH-SI 1/ 50A GG AC400V LI AK	1	50	3	NH-SI 1/ 50A GG AC400V LI AK	<b>35408-0500</b>
NH-SI 1/ 63A GG AC400V LI AK	1	63	3	NH-SI 1/ 63A GG AC400V LI AK	<b>35408-0630</b>
NH-SI 1/ 80A GG AC400V LI AK	1	80	3	NH-SI 1/ 80A GG AC400V LI AK	<b>35408-0800</b>
NH-SI 1/ 100A GG AC400V LI AK	1	100	3	NH-SI 1/ 100A GG AC400V LI AK	<b>35408-1000</b>
NH-SI 1 125A GG AC400V LI AK	1	125	3	NH-SI 1 125A GG AC400V LI AK	<b>35408-1250</b>
NH-SI 1 160A GG AC400V LI AK	1	160	3	NH-SI 1 160A GG AC400V LI AK	<b>35408-1600</b>
NH-SI 1 200A GG AC400V LI AK	1	200	3	NH-SI 1 200A GG AC400V LI AK	<b>35408-2000</b>
NH-SI 1 224A GG AC400V LI AK	1	224	3	NH-SI 1 224A GG AC400V LI AK	<b>35408-2240</b>
NH-SI 1 250A GG AC400V LI AK	1	250	3	NH-SI 1 250A GG AC400V LI AK	<b>35408-2500</b>

## NH Fuse-Links 400V gG

- Rated voltage: AC 400V
- Utilization category: gG acc. to VDE 0636-2 and VDE 0636-1
- IEC 60269-2 and IEC 60269-1
- Breaking capacity: 100kA

► Technical data, page 32



35407-1600

### NH Fuse-Links for cable and line protection, 400V AC gG

#### Features:

- Twin indicator (size 3, 500 A and 630 A with center indicator)
- Insulated metal gripping lug
- Copper fuse element

Designation	Size	Amps	PU	Product designation	Order no.
NH-SI 2/ 35A GG AC400V LI AK	2	35	3	NH-SI 2/ 35A GG AC400V LI AK	<b>35409-0350</b>
NH-SI 2/ 50A GG AC400V LI AK	2	50	3	NH-SI 2/ 50A GG AC400V LI AK	<b>35409-0500</b>
NH-SI 2/ 63A GG AC400V LI AK	2	63	3	NH-SI 2/ 63A GG AC400V LI AK	<b>35409-0630</b>
NH-SI 2/ 80A GG AC400V LI AK	2	80	3	NH-SI 2/ 80A GG AC400V LI AK	<b>35409-0800</b>
NH-SI 2/ 100A GG AC400V LI AK	2	100	3	NH-SI 2/ 100A GG AC400V LI AK	<b>35409-1000</b>
NH-SI 2/ 125A GG AC400V LI AK	2	125	3	NH-SI 2/ 125A GG AC400V LI AK	<b>35409-1250</b>
NH-SI 2/ 160A GG AC400V LI AK	2	160	3	NH-SI 2/ 160A GG AC400V LI AK	<b>35409-1600</b>
NH-SI 2/ 200A GG AC400V LI AK	2	200	3	NH-SI 2/ 200A GG AC400V LI AK	<b>35409-2000</b>
NH-SI 2/ 224A GG AC400V LI AK	2	224	3	NH-SI 2/ 224A GG AC400V LI AK	<b>35409-2240</b>
NH-SI 2/ 250A GG AC400V LI AK	2	250	3	NH-SI 2/ 250A GG AC400V LI AK	<b>35409-2500</b>
NH-SI 2 315A GG AC400V LI AK	2	315	3	NH-SI 2 315A GG AC400V LI AK	<b>35409-3150</b>
NH-SI 2 355A GG AC400V LI AK	2	355	3	NH-SI 2 355A GG AC400V LI AK	<b>35409-3550</b>
NH-SI 2 400A GG AC400V LI AK	2	400	3	NH-SI 2 400A GG AC400V LI AK	<b>35409-4000</b>
NH-SI 3/ 250A GG AC400V LI AK	3	250	1	NH-SI 3/ 250A GG AC400V LI AK	<b>35410-2500</b>
NH-SI 3/ 300A GG AC400V LI AK	3	300	1	NH-SI 3/ 300A GG AC400V LI AK	<b>35410-3000</b>
NH-SI 3/ 315A GG AC400V LI AK	3	315	1	NH-SI 3/ 315A GG AC400V LI AK	<b>35410-3150</b>
NH-SI 3/ 400A GG AC400V LI AK	3	400	1	NH-SI 3/ 400A GG AC400V LI AK	<b>35410-4000</b>
NH-SI 3 500A GG AC400V LI MA	3	500	1	NH-SI 3 500A GG AC400V LI Ma	<b>35410-5000</b>
NH-SI 3 630A GG AC400V LI MA	3	630	1	NH-SI 3 630A GG AC400V LI Ma	<b>35410-6300</b>

## NH Fuse-Links 500 V gG

- Rated voltage: AC 500 V
- Utilization category: gG acc. to VDE 0636-2 and VDE 0636-1
- IEC 60269-2
- Breaking capacity AC: 120 kA
- Breaking capacity DC: see technical data

► Technical data, page 36



35000-0800

### NH Fuse-Links for cable and line protection, 500 V AC gG

#### Features:

- Twin indicator
- Non-insulated metal gripping lug
- Copper fuse element

Designation	Size	Amps	PU	Product designation	Order no.
NH-SI 000 2A GG AC500V AK	000	2	3	NH-SI 000 2A GG AC500V AK	<b>35000-0020</b>
NH-SI 000 4,0A GG AC500V AK	000	4	3	NH-SI 000 4,0A GG AC500V AK	<b>35000-0040</b>
NH-SI 000 6A GG AC500V AK	000	6	3	NH-SI 000 6A GG AC500V AK	<b>35000-0060</b>
NH-SI 000 10A GG AC500V AK	000	10	3	NH-SI 000 10A GG AC500V AK	<b>35000-0100</b>
NH-SI 000 16A GG AC500V AK	000	16	3	NH-SI 000 16A GG AC500V AK	<b>35000-0160</b>
NH-SI 000 20A GG AC500V AK	000	20	3	NH-SI 000 20A GG AC500V AK	<b>35000-0200</b>
NH-SI 000 25A GG AC500V AK	000	25	3	NH-SI 000 25A GG AC500V AK	<b>35000-0250</b>
NH-SI 000 32A GG AC500V AK	000	32	3	NH-SI 000 32A GG AC500V AK	<b>35000-0320</b>
NH-SI 000 35A GG AC500V AK	000	35	3	NH-SI 000 35A GG AC500V AK	<b>35000-0350</b>
NH-SI 000 40A GG AC500V AK	000	40	3	NH-SI 000 40A GG AC500V AK	<b>35000-0400</b>
NH-SI 000 50A GG AC500V AK	000	50	3	NH-SI 000 50A GG AC500V AK	<b>35000-0500</b>
NH-SI 000 63A GG AC500V AK	000	63	3	NH-SI 000 63A GG AC500V AK	<b>35000-0630</b>
NH-SI 000 80A GG AC500V AK	000	80	3	NH-SI 000 80A GG AC500V AK	<b>35000-0800</b>
NH-SI 000 100A GG AC500V AK	000	100	3	NH-SI 000 100A GG AC500V AK	<b>35000-1000</b>
NH-SI 00 25A GG AC500V AK	00	16	3	NH-SI 00 16A GG AC500V AK	<b>35011-0050</b>
NH-SI 00 25A GG AC500V AK	00	20	3	NH-SI 00 20A GG AC500V AK	<b>35011-0060</b>
NH-SI 00 25A GG AC500V AK	00	25	3	NH-SI 00 25A GG AC500V AK	<b>35011-0070</b>
NH-SI 00 32A GG AC500V AK	00	32	3	NH-SI 00 32A GG AC500V AK	<b>35011-0080</b>
NH-SI 00 35A GG AC500V AK	00	35	3	NH-SI 00 35A GG AC500V AK	<b>35011-0090</b>
NH-SI 00 40A GG AC500V AK	00	40	3	NH-SI 00 40A GG AC500V AK	<b>35011-0100</b>
NH-SI 00 50A GG AC500V AK	00	50	3	NH-SI 00 50A GG AC500V AK	<b>35011-0110</b>
NH-SI 00 63A GG AC500V AK	00	63	3	NH-SI 00 63A GG AC500V AK	<b>35011-0120</b>
NH-SI 00 80A GG AC500V AK	00	80	3	NH-SI 00 80A GG AC500V AK	<b>35011-0130</b>
NH-SI 00 100A GG AC500V AK	00	100	3	NH-SI 00 100A GG AC500V AK	<b>35011-0140</b>
NH-SI 00 125A GG AC500V AK	00	125	3	NH-SI 00 125A GG AC500V AK	<b>35011-0150</b>
NH-SI 00 160A GG AC500V AK	00	160	3	NH-SI 00 160A GG AC500V AK	<b>35011-1090</b>
NH-SI 1/25A GG AC500V AK	1	25	3	NH-SI 1/ 25A GG AC500V AK	<b>35035-0050</b>
NH-SI 1/32A GG AC500V AK	1	32	3	NH-SI 1/ 32A GG AC500V AK	<b>35035-1220</b>
NH-SI 1/35A GG AC500V AK	1	35	3	NH-SI 1/ 35A GG AC500V AK	<b>35035-0060</b>
NH-SI 1/40A GG AC500V AK	1	40	3	NH-SI 1/ 40A GG AC500V AK	<b>35035-1230</b>
NH-SI 1/50A GG AC500V AK	1	50	3	NH-SI 1/ 50A GG AC500V AK	<b>35035-0070</b>
NH-SI 1/63A GG AC500V AK	1	63	3	NH-SI 1/ 63A GG AC500V AK	<b>35035-0080</b>
NH-SI 1/80A GG AC500V AK	1	80	3	NH-SI 1/ 80A GG AC500V AK	<b>35035-0090</b>
NH-SI 1/100A GG AC500V AK	1	100	3	NH-SI 1/ 100A GG AC500V AK	<b>35035-0100</b>
NH-SI 1/125A GG AC500V AK	1	125	3	NH-SI 1 125A GG AC500V AK	<b>35035-0110</b>
NH-SI 1/160A GG AC500V AK	1	160	3	NH-SI 1 160A GG AC500V AK	<b>35035-0120</b>
NH-SI 1 200A GG AC500V AK	1	200	3	NH-SI 1 200A GG AC500V AK	<b>35035-0130</b>
NH-SI 1 224A GG AC500V AK	1	224	3	NH-SI 1 224A GG AC500V AK	<b>35035-0140</b>
NH-SI 1 250A GG AC500V AK	1	250	3	NH-SI 1 250A GG AC500V AK	<b>35035-0150</b>

## NH Fuse-Links 500 V gG

- Rated voltage: AC 500 V
- Utilization category: gG acc. to VDE 0636-2 and VDE 0636-1
- IEC 60269 -2
- Breaking capacity AC: 120 kA
- Breaking capacity DC: see technical data

► Technical data, page 36



35054-0150

### NH Fuse-Links for cable and line protection, 500 V AC gG

#### Features:

- Twin indicator (size 4a with center indicator)
- Non-insulated metal gripping lug
- Copper fuse element

Designation	Size	Amps	PU	Product designation	Order no.
NH-SI 2/25A GG AC500V AK	2	25	3	NH-SI 2/ 25A GG AC500V AK	<b>35054-0010</b>
NH-SI 2/35A GG AC500V AK	2	35	3	NH-SI 2/ 35A GG AC500V AK	<b>35054-0020</b>
NH-SI 2/50A GG AC500V AK	2	50	3	NH-SI 2/ 50A GG AC500V AK	<b>35054-0030</b>
NH-SI 2/63A GG AC500V AK	2	63	3	NH-SI 2/ 63A GG AC500V AK	<b>35054-0040</b>
NH-SI 2/80A GG AC500V AK	2	80	3	NH-SI 2/ 80A GG AC500V AK	<b>35054-0050</b>
NH-SI 2/100A GG AC500V AK	2	100	3	NH-SI 2/ 100A GG AC500V AK	<b>35054-0060</b>
NH-SI 2/125A GG AC500V AK	2	125	3	NH-SI 2/ 125A GG AC500V AK	<b>35054-0070</b>
NH-SI 2/160A GG AC500V AK	2	160	3	NH-SI 2/ 160A GG AC500V AK	<b>35054-0080</b>
NH-SI 2/200A GG AC500V AK	2	200	3	NH-SI 2/ 200A GG AC500V AK	<b>35054-0090</b>
NH-SI 2/224A GG AC500V AK	2	224	3	NH-SI 2/ 224A GG AC500V AK	<b>35054-0100</b>
NH-SI 2/250A GG AC500V AK	2	250	3	NH-SI 2/ 250A GG AC500V AK	<b>35054-0110</b>
NH-SI 2 300A GG AC500V AK	2	300	3	NH-SI 2 300A GG AC500V AK	<b>35054-0120</b>
NH-SI 2 315A GG AC500V AK	2	315	3	NH-SI 2 315A GG AC500V AK	<b>35054-0130</b>
NH-SI 2 355A GG AC500V AK	2	355	3	NH-SI 2 355A GG AC500V AK	<b>35054-0140</b>
NH-SI 2 400A GG AC500V AK	2	400	3	NH-SI 2 400A GG AC500V AK	<b>35054-0150</b>
NH-SI 3/63A GG AC500V AK	3	63	3	NH-SI 3/ 63A GG AC500V AK	<b>35078-0340</b>
NH-SI 3/80A GG AC500V AK	3	80	3	NH-SI 3/ 80A GG AC500V AK	<b>35078-0350</b>
NH-SI 3/100A GG AC500V AK	3	100	3	NH-SI 3/ 100A GG AC500V AK	<b>35078-0360</b>
NH-SI 3/125A GG AC500V AK	3	125	3	NH-SI 3/ 125A GG AC500V AK	<b>35078-0370</b>
NH-SI 3/160A GG AC500V AK	3	160	3	NH-SI 3/ 160A GG AC500V AK	<b>35078-0380</b>
NH-SI 3/200A GG AC500V AK	3	200	3	NH-SI 3/ 200A GG AC500V AK	<b>35078-0390</b>
NH-SI 3/224A GG AC500V AK	3	224	3	NH-SI 3/ 224A GG AC500V AK	<b>35078-0400</b>
NH-SI 3/250A GG AC500V AK	3	250	3	NH-SI 3/ 250A GG AC500V AK	<b>35078-0410</b>
NH-SI 3/300A GG AC500V AK	3	300	3	NH-SI 3/ 300A GG AC500V AK	<b>35078-0190</b>
NH-SI 3/315A GG AC500V AK	3	315	3	NH-SI 3/ 315A GG AC500V AK	<b>35078-0010</b>
NH-SI 3/355A GG AC500V AK	3	355	3	NH-SI 3/ 355A GG AC500V AK	<b>35078-0020</b>
NH-SI 3/400A GG AC500V AK	3	400	3	NH-SI 3/ 400A GG AC500V AK	<b>35078-0030</b>
NH-SI 3 500A GG AC500V AK	3	500	3	NH-SI 3 500A GG AC500V AK	<b>35078-0050</b>
NH-SI 3 630A GG AC500V AK	3	630	3	NH-SI 3 630A GG AC500V AK	<b>35078-0060</b>
NH-SI 4A 400A GG AC500V	4a	400	3	NH-SI 4A 400A GG AC500V	<b>35097-0120</b>
NH-SI 4A 500A GG AC500V	4a	500	3	NH-SI 4A 500A GG AC500V	<b>35097-0010</b>
NH-SI 4A 630A GG AC500V	4a	630	3	NH-SI 4A 630A GG AC500V	<b>35097-0020</b>
NH-SI 4A 800A GG AC500V	4a	800	1	NH-SI 4A 800A GG AC500V	<b>35097-0030</b>
NH-SI 4A 1000A GG AC500V	4a	1000	1	NH-SI 4A 1000A GG AC500V	<b>35097-0040</b>
NH-SI 4A 1250A GG AC500V	4a	1250	1	NH-SI 4A 1250A GG AC500V	<b>35097-0050</b>
NH-SI 4A 1600A GG AC500V	4a	1600	1	NH-SI 4A 1600A GG AC500V	<b>35097-0110</b>

## NH Fuse-Links 500 V gG

- Rated voltage: AC 500 V
- Utilization category: gG acc. to VDE 0636-2 and VDE 0636-1
- IEC 60269 -2
- Breaking capacity AC: 120 kA
- Breaking capacity DC: see technical data

► Technical data, page 36



35001-1000

### NH Fuse-Links for cable and line protection, 500 V AC gG

#### Features:

- Twin indicator
- Insulated metal gripping lug
- Copper fuse element

Designation	Size	Amps	PU	Product designation	Order no.
NH-SI 000 2A GG AC500V LI AK	000	2	10	NH-SI 000 2A GG AC500V LI AK	<b>35001-0020</b>
NH-SI 000 4,0A GG AC500V LI AK	000	4	10	NH-SI 000 4,0A GG AC500V LI AK	<b>35001-0040</b>
NH-SI 000 6A GG AC500V LI AK	000	6	10	NH-SI 000 6A GG AC500V LI AK	<b>35001-0060</b>
NH-SI 000 10A GG AC500V LI AK	000	10	10	NH-SI 000 10A GG AC500V LI AK	<b>35001-0100</b>
NH-SI 000 16A GG AC500V LI AK	000	16	10	NH-SI 000 16A GG AC500V LI AK	<b>35001-0160</b>
NH-SI 000 20A GG AC500V LI AK	000	20	10	NH-SI 000 20A GG AC500V LI AK	<b>35001-0200</b>
NH-SI 000 25A GG AC500V LI AK	000	25	10	NH-SI 000 25A GG AC500V LI AK	<b>35001-0250</b>
NH-SI 000 32A GG AC500V LI AK	000	32	10	NH-SI 000 32A GG AC500V LI AK	<b>35001-0320</b>
NH-SI 000 35A GG AC500V LI AK	000	35	10	NH-SI 000 35A GG AC500V LI AK	<b>35001-0350</b>
NH-SI 000 40A GG AC500V LI AK	000	40	10	NH-SI 000 40A GG AC500V LI AK	<b>35001-0400</b>
NH-SI 000 50A GG AC500V LI AK	000	50	10	NH-SI 000 50A GG AC500V LI AK	<b>35001-0500</b>
NH-SI 000 63A GG AC500V LI AK	000	63	10	NH-SI 000 63A GG AC500V LI AK	<b>35001-0630</b>
NH-SI 000 80A GG AC500V LI AK	000	80	10	NH-SI 000 80A GG AC500V LI AK	<b>35001-0800</b>
NH-SI 000 100A GG AC500V LI AK	000	100	10	NH-SI 000 100A GG AC500V LI AK	<b>35001-1000</b>
NH-SI 00 25A GG AC500V LI AK	00	25	3	NH-SI 00 25A GG AC500V LI AK	<b>35165-0070</b>
NH-SI 00 32A GG AC500V LI AK	00	32	3	NH-SI 00 32A GG AC500V LI AK	<b>35165-0080</b>
NH-SI 00 35A GG AC500V LI AK	00	35	3	NH-SI 00 35A GG AC500V LI AK	<b>35165-0090</b>
NH-SI 00 40A GG AC500V LI AK	00	40	3	NH-SI 00 40A GG AC500V LI AK	<b>35165-0100</b>
NH-SI 00 50A GG AC500V LI AK	00	50	3	NH-SI 00 50A GG AC500V LI AK	<b>35165-0110</b>
NH-SI 00 63A GG AC500V LI AK	00	63	3	NH-SI 00 63A GG AC500V LI AK	<b>35165-0120</b>
NH-SI 00 80A GG AC500V LI AK	00	80	3	NH-SI 00 80A GG AC500V LI AK	<b>35165-0130</b>
NH-SI 00 100A GG AC500V LI AK	00	100	3	NH-SI 00 100A GG AC500V LI AK	<b>35165-0140</b>
NH-SI 00 125A GG AC500V LI AK	00	125	3	NH-SI 00 125A GG AC500V LI AK	<b>35165-0150</b>
NH-SI 00 160A GG AC500V LI AK	00	160	3	NH-SI 00 160A GG AC500V LI AK	<b>35165-0160</b>
NH-SI 1/ 25A GG AC500V LI AK	1	25	3	NH-SI 1/ 25A GG AC500V LI AK	<b>35204-0050</b>
NH-SI 1/ 32A GG AC500V LI AK	1	32	3	NH-SI 1/ 32A GG AC500V LI AK	<b>35204-0160</b>
NH-SI 1/ 35A GG AC500V LI AK	1	35	3	NH-SI 1/ 35A GG AC500V LI AK	<b>35204-0060</b>
NH-SI 1/ 40A GG AC500V LI AK	1	40	3	NH-SI 1/ 40A GG AC500V LI AK	<b>35204-0170</b>
NH-SI 1/ 50A GG AC500V LI AK	1	50	3	NH-SI 1/ 50A GG AC500V LI AK	<b>35204-0070</b>
NH-SI 1/ 63A GG AC500V LI AK	1	63	3	NH-SI 1/ 63A GG AC500V LI AK	<b>35204-0080</b>
NH-SI 1/ 80A GG AC500V LI AK	1	80	3	NH-SI 1/ 80A GG AC500V LI AK	<b>35204-0090</b>
NH-SI 1/ 100A GG AC500V LI AK	1	100	3	NH-SI 1/ 100A GG AC500V LI AK	<b>35204-0100</b>
NH-SI 1 125A GG AC500V LI AK	1	125	3	NH-SI 1 125A GG AC500V LI AK	<b>35204-0110</b>
NH-SI 1 160A GG AC500V LI AK	1	160	3	NH-SI 1 160A GG AC500V LI AK	<b>35204-0120</b>
NH-SI 1 200A GG AC500V LI AK	1	200	3	NH-SI 1 200A GG AC500V LI AK	<b>35204-0130</b>
NH-SI 1 224A GG AC500V LI AK	1	224	3	NH-SI 1 224A GG AC500V LI AK	<b>35204-0140</b>
NH-SI 1 250A GG AC500V LI AK	1	250	3	NH-SI 1 250A GG AC500V LI AK	<b>35204-0150</b>
NH-SI 2/ 63A GG AC500V LI AK	2	63	3	NH-SI 2/ 63A GG AC500V LI AK	<b>35116-0040</b>
NH-SI 2/ 80A GG AC500V LI AK	2	80	3	NH-SI 2/ 80A GG AC500V LI AK	<b>35116-0050</b>
NH-SI 2/ 100A GG AC500V LI AK	2	100	3	NH-SI 2/ 100A GG AC500V LI AK	<b>35116-0060</b>
NH-SI 2/ 125A GG AC500V LI AK	2	125	3	NH-SI 2/ 125A GG AC500V LI AK	<b>35116-0070</b>
NH-SI 2/ 160A GG AC500V LI AK	2	160	3	NH-SI 2/ 160A GG AC500V LI AK	<b>35116-0080</b>
NH-SI 2/ 200A GG AC500V LI AK	2	200	3	NH-SI 2/ 200A GG AC500V LI AK	<b>35116-0090</b>
NH-SI 2/ 224A GG AC500V LI AK	2	224	3	NH-SI 2/ 224A GG AC500V LI AK	<b>35116-0100</b>
NH-SI 2/ 250A GG AC500V LI AK	2	250	3	NH-SI 2/ 250A GG AC500V LI AK	<b>35116-0110</b>
NH-SI 2 300A GG AC500V LI AK	2	300	3	NH-SI 2 300A GG AC500V LI AK	<b>35116-0120</b>
NH-SI 2 315A GG AC500V LI AK	2	315	3	NH-SI 2 315A GG AC500V LI AK	<b>35116-0130</b>
NH-SI 2 355A GG AC500V LI AK	2	355	3	NH-SI 2 355A GG AC500V LI AK	<b>35116-0140</b>
NH-SI 2 400A GG AC500V LI AK	2	400	3	NH-SI 2 400A GG AC500V LI AK	<b>35116-0150</b>

## NH Fuse-Links 500 V gG

- Rated voltage: AC 500 V
- Utilization category: gG acc. to VDE 0636-2 and VDE 0636-1
- IEC 60269-2
- Breaking capacity AC: 120 kA
- Breaking capacity DC: see technical data

► Technical data, page 36



35001-1000

### NH Fuse-Links for cable and line protection, 500 V AC gG

**Features:**

- Twin indicator
- Insulated metal gripping lug
- Copper fuse element

Designation	Size	Amps	PU	Product designation	Order no.
NH-SI 3/ 100A gG AC500V LI AK	3	100	3	NH-SI 3/ 100A gG AC500V LI AK	<b>35420-1000</b>
NH-SI 3/ 125A gG AC500V LI AK	3	125	3	NH-SI 3/ 125A gG AC500V LI AK	<b>35420-1250</b>
NH-SI 3/ 160A gG AC500V LI AK	3	160	3	NH-SI 3/ 160A gG AC500V LI AK	<b>35420-1600</b>
NH-SI 3/ 200A gG AC500V LI AK	3	200	3	NH-SI 3/ 200A gG AC500V LI AK	<b>35420-2000</b>
NH-SI 3/ 224A gG AC500V LI AK	3	224	3	NH-SI 3/ 224A gG AC500V LI AK	<b>35420-2240</b>
NH-SI 3/ 250A gG AC500V LI AK	3	250	3	NH-SI 3/ 250A gG AC500V LI AK	<b>35420-2500</b>
NH-SI 3/ 300A gG AC500V LI AK	3	300	3	NH-SI 3/ 300A gG AC500V LI AK	<b>35420-3000</b>
NH-SI 3/ 315A GG AC500V LI AK	3	315	3	NH-SI 3/ 315A GG AC500V LI AK	<b>35420-3150</b>
NH-SI 3/ 355A GG AC500V LI AK	3	355	3	NH-SI 3/ 355A GG AC500V LI AK	<b>35420-3550</b>
NH-SI 3/ 400A GG AC500V LI AK	3	400	3	NH-SI 3/ 400A GG AC500V LI AK	<b>35420-4000</b>
NH-SI 3 425A GG AC500V LI AK	3	425	3	NH-SI 3 425A GG AC500V LI AK	<b>35420-4250</b>
NH-SI 3 425A GG AC500V LI AK	3	425	3	NH-SI 3 425A GG AC500V LI AK	<b>35420-5000</b>
NH-SI 3 630A GG AC500V LI AK	3	630	3	NH-SI 3 630A GG AC500V LI AK	<b>35420-6300</b>

# NH Fuse-Links 500 V gL

- Rated voltage: AC 500 V / DC 440 V\*
- Utilization category: gL acc. to VDE 0636-21 and VDE 0636-1
- IEC 60269-2
- Breaking capacity AC: 120 kA
- Breaking capacity DC: see technical data

► Technical data, page 36



35207-0130

## NH Fuse-Links for cable and line protection, AC 500 V gL

### Features:

- Striker pin for fuse monitoring
- Non-insulated metal gripping lug
- Copper fuse element

Designation	Size	Amps	PU	Product designation	Order no.
NH-Si 00 6A gL SM	00	6	10	NH-SI 00 6A GL AC500V SM	<b>35207-0010</b>
NH-Si 00 10A gL SM	00	10	10	NH-SI 00 10A GL AC500V SM	<b>35207-0020</b>
NH-Si 00 16A gL SM	00	16	10	NH-SI 00 16A GL AC500V SM	<b>35207-0030</b>
NH-Si 00 20A gL SM	00	20	10	NH-SI 00 20A GL AC500V SM	<b>35207-0040</b>
NH-Si 00 25A gL SM	00	25	10	NH-SI 00 25A GL AC500V SM	<b>35207-0050</b>
NH-Si 00 32A gL SM	00	32	10	NH-SI 00 32A GL AC500V SM	<b>35207-0060</b>
NH-Si 00 35A gL SM	00	35	10	NH-SI 00 35A GL AC500V SM	<b>35207-0070</b>
NH-Si 00 40A gL SM	00	40	10	NH-SI 00 40A GL AC500V SM	<b>35207-0080</b>
NH-Si 00 50A gL SM	00	50	10	NH-SI 00 50A GL AC500V SM	<b>35207-0090</b>
NH-Si 00 63A gL SM	00	63	10	NH-SI 00 63A GL AC500V SM	<b>35207-0100</b>
NH-Si 00 80A gL SM	00	80	10	NH-SI 00 80A GL AC500V SM	<b>35207-0110</b>
NH-Si 00 100A gL SM	00	100	10	NH-SI 00 100A GL AC500V SM	<b>35207-0120</b>
NH-Si 00 125A gL SM	00	125	10	NH-SI 00 125A GL AC500V SM	<b>35207-0130</b>

## NH Fuse-Links 500 V gL

- Rated voltage: AC 500 V / DC 440 V\*
- Utilization category: gL acc. to VDE 0636-21 and VDE 0636-1
- IEC 60269-2
- Breaking capacity AC: 120 kA
- Breaking capacity DC: see technical data

► Technical data, page 36



35010-0160

### NH Fuse-Links for cable and line protection, AC 500 V gL

#### Features:

- Center indicator
- Non-insulated metal gripping lug
- Pure silver fuse element

Designation	Size	Amps	PU	Product designation	Order no.
NH-SI 00 2A GL AG AC500V	00	2	10	NH-SI 00 2A GL AG AC500V	<b>35010-0010</b>
NH-SI 00 4A GL AG AC500V	00	4	10	NH-SI 00 4A GL AG AC500V	<b>35010-0020</b>
NH-SI 00 6A GL AG AC500V	00	6	10	NH-SI 00 6A GL AG AC500V	<b>35010-0030</b>
NH-SI 00 10A GL AG AC500V	00	10	10	NH-SI 00 10A GL AG AC500V	<b>35010-0040</b>
NH-SI 00 16A GL AG AC500V	00	16	10	NH-SI 00 16A GL AG AC500V	<b>35010-0050</b>
NH-SI 00 20A GL AG AC500V	00	20	10	NH-SI 00 20A GL AG AC500V	<b>35010-0060</b>
NH-SI 00 25A GL AG AC500V	00	25	10	NH-SI 00 25A GL AG AC500V	<b>35010-0070</b>
NH-SI 00 32A GL AG AC500V	00	32	10	NH-SI 00 32A GL AG AC500V	<b>35010-0080</b>
NH-SI 00 35A GL AG AC500V	00	35	10	NH-SI 00 35A GL AG AC500V	<b>35010-0090</b>
NH-SI 00 40A GL AG AC500V	00	40	10	NH-SI 00 40A GL AG AC500V	<b>35010-0100</b>
NH-SI 00 50A GL AG AC500V	00	50	10	NH-SI 00 50A GL AG AC500V	<b>35010-0110</b>
NH-SI 00 63A GL AG AC500V	00	63	10	NH-SI 00 63A GL AG AC500V	<b>35010-0120</b>
NH-SI 00 80A GL AG AC500V	00	80	10	NH-SI 00 80A GL AG AC500V	<b>35010-0130</b>
NH-SI 00 100A GL AG AC500V	00	100	10	NH-SI 00 100A GL AG AC500V	<b>35010-0140</b>
NH-SI 00 125A GL AG AC500V	00	125	10	NH-SI 00 125A GL AG AC500V	<b>35010-0150</b>
NH-SI 00 160A GL AG AC500V	00	160	10	NH-SI 00 160A GL AG AC500V	<b>35010-0160</b>
NH-SI 1/6A GL AG AC500V	1	6	3	NH-SI 1/ 6A GL AG AC500V	<b>35034-0010</b>
NH-SI 1/10A GL AG AC500V	1	10	3	NH-SI 1/ 10A GL AG AC500V	<b>35034-0020</b>
NH-SI 1/16A GL AG AC500V	1	16	3	NH-SI 1/ 16A GL AG AC500V	<b>35034-0030</b>
NH-SI 1/20A GL AG AC500V	1	20	3	NH-SI 1/ 20A GL AG AC500V	<b>35034-0040</b>
NH-SI 1/25A GL AG AC500V	1	25	3	NH-SI 1/ 25A GL AG AC500V	<b>35034-0050</b>
NH-SI 1/35A GL AG AC500V	1	35	3	NH-SI 1/ 35A GL AG AC500V	<b>35034-0060</b>
NH-SI 1/50A GL AG AC500V	1	50	3	NH-SI 1/ 50A GL AG AC500V	<b>35034-0070</b>
NH-SI 1/63A GL AG AC500V	1	63	3	NH-SI 1/ 63A GL AG AC500V	<b>35034-0080</b>
NH-SI 1/80A GL AG AC500V	1	80	3	NH-SI 1/ 80A GL AG AC500V	<b>35034-0090</b>
NH-SI 1/100A GL AG AC500V	1	100	3	NH-SI 1/ 100A GL AG AC500V	<b>35034-0100</b>
NH-SI 1/125A GL AG AC500V	1	125	3	NH-SI 1/ 125A GL AG AC500V	<b>35034-0110</b>
NH-SI 1 160A GL AG AC500V	1	160	3	NH-SI 1 160A GL AG AC500V	<b>35034-0120</b>
NH-SI 1 200A GL AG AC500V	1	200	3	NH-SI 1 200A GL AG AC500V	<b>35034-0130</b>
NH-SI 1 224A GL AG AC500V	1	224	3	NH-SI 1 224A GL AG AC500V	<b>35034-0140</b>
NH-SI 1 250A GL AG AC500V	1	250	3	NH-SI 1 250A GL AG AC500V	<b>35034-0150</b>
NH-SI 2/25A GL AG AC500V	2	25	3	NH-SI 2/ 25A GL AG AC500V	<b>35053-0010</b>
NH-SI 2/35A GL AG AC500V	2	35	3	NH-SI 2/ 35A GL AG AC500V	<b>35053-0020</b>
NH-SI 2/50A GL AG AC500V	2	50	3	NH-SI 2/ 50A GL AG AC500V	<b>35053-0030</b>
NH-SI 2/63A GL AG AC500V	2	63	3	NH-SI 2/ 63A GL AG AC500V	<b>35053-0040</b>
NH-SI 2/80A GL AG AC500V	2	80	3	NH-SI 2/ 80A GL AG AC500V	<b>35053-0050</b>
NH-SI 2/100A GL AG AC500V	2	100	3	NH-SI 2/ 100A GL AG AC500V	<b>35053-0060</b>
NH-SI 2/125A GL AG AC500V	2	125	3	NH-SI 2/ 125A GL AG AC500V	<b>35053-0070</b>
NH-SI 2/160A GL AG AC500V	2	160	3	NH-SI 2/ 160A GL AG AC500V	<b>35053-0080</b>
NH-SI 2/200A GL AG AC500V	2	200	3	NH-SI 2/ 200A GL AG AC500V	<b>35053-0090</b>
NH-SI 2/224A GL AG AC500V	2	224	3	NH-SI 2/ 224A GL AG AC500V	<b>35053-0100</b>
NH-SI 2 250A GL AG AC500V	2	250	3	NH-SI 2 250A GL AG AC500V	<b>35053-0110</b>
NH-SI 2 300A GL AG AC500V	2	300	3	NH-SI 2 300A GL AG AC500V	<b>35053-0120</b>
NH-SI 2 315A GL AG AC500V	2	315	3	NH-SI 2 315A GL AG AC500V	<b>35053-0130</b>
NH-SI 2 355A GL AG AC500V	2	355	3	NH-SI 2 355A GL AG AC500V	<b>35053-0140</b>
NH-SI 2 400A GL AG AC500V	2	400	3	NH-SI 2 400A GL AG AC500V	<b>35053-0150</b>
NH-SI 3 315A GL AG AC500V	3	315	3	NH-SI 3 315A GL AG AC500V	<b>35077-0010</b>
NH-SI 3 355A GL AG AC500V	3	355	3	NH-SI 3 355A GL AG AC500V	<b>35077-0020</b>
NH-SI 3 400A GL AG AC500V	3	400	3	NH-SI 3 400A GL AG AC500V	<b>35077-0030</b>
NH-SI 3 425A GL AG AC500V	3	425	3	NH-SI 3 425A GL AG AC500V	<b>35077-0040</b>
NH-SI 3 500A GL AG AC500V	3	500	3	NH-SI 3 500A GL AG AC500V	<b>35077-0050</b>
NH-SI 3 630A GL AG AC500V	3	630	3	NH-SI 3 630A GL AG AC500V	<b>35077-0060</b>

# NH Fuse-Links 500V gL

- Rated voltage: AC 500V / DC 440V\*
- Utilization category: gL acc. to VDE 0636-21 and VDE 0636-1
- IEC 60269-2
- Breaking capacity AC: 120 kA
- Breaking capacity DC: see technical data

► Technical data, page 36



35164-0160

## NH Fuse-Links for cable and line protection, AC 500V gL

### Features:

- Center indicator
- Insulated metal gripping lug
- Pure silver fuse element

Designation	Size	Amps	PU	Product designation	Order no.
NH-SI 00 2A GL AG AC500V LI	00	2	10	NH-SI 00 2A GL AG AC500V LI	<b>35164-0010</b>
NH-SI 00 4A GL AG AC500V LI	00	4	10	NH-SI 00 4,0A GL AG AC500V LI	<b>35164-0020</b>
NH-SI 00 6A GL AG AC500V LI	00	6	10	NH-SI 00 6A GL AG AC500V LI	<b>35164-0030</b>
NH-SI 00 10A GL AG AC500V LI	00	10	10	NH-SI 00 10A GL AG AC500V LI	<b>35164-0040</b>
NH-SI 00 16A GL AG AC500V LI	00	16	10	NH-SI 00 16A GL AG AC500V LI	<b>35164-0050</b>
NH-SI 00 20A GL AG AC500V LI	00	20	10	NH-SI 00 20A GL AG AC500V LI	<b>35164-0060</b>
NH-SI 00 25A GL AG AC500V LI	00	25	10	NH-SI 00 25A GL AG AC500V LI	<b>35164-0070</b>
NH-SI 00 32A GL AG AC500V LI	00	32	10	NH-SI 00 32A GL AG AC500V LI	<b>35164-0080</b>
NH-SI 00 35A GL AG AC500V LI	00	35	10	NH-SI 00 35A GL AG AC500V LI	<b>35164-0090</b>
NH-SI 00 40A GL AG AC500V LI	00	40	10	NH-SI 00 40A GL AG AC500V LI	<b>35164-0100</b>
NH-SI 00 50A GL AG AC500V LI	00	50	10	NH-SI 00 50A GL AG AC500V LI	<b>35164-0110</b>
NH-SI 00 63A GL AG AC500V LI	00	63	10	NH-SI 00 63A GL AG AC500V LI	<b>35164-0120</b>
NH-SI 00 80A GL AG AC500V LI	00	80	10	NH-SI 00 80A GL AG AC500V LI	<b>35164-0130</b>
NH-SI 00 100A GL AG AC500V LI	00	100	10	NH-SI 00 100A GL AG AC500V LI	<b>35164-0140</b>
NH-SI 00 125A GL AG AC500V LI	00	125	10	NH-SI 00 125A GL AG AC500V LI	<b>35164-0150</b>
NH-SI 00 160A GL AG AC500V LI	00	160	10	NH-SI 00 160A GL AG AC500V LI	<b>35164-0160</b>
NH-SI 1 6A GL AG AC500V LI	1	6	3	NH-SI 1 6A GL AG AC500V LI	<b>35203-0010</b>
NH-SI 1 10A GL AG AC500V LI	1	10	3	NH-SI 1 10A GL AG AC500V LI	<b>35203-0020</b>
NH-SI 1 16A GL AG AC500V LI	1	16	3	NH-SI 1 16A GL AG AC500V LI	<b>35203-0030</b>
NH-SI 1 20A GL AG AC500V LI	1	20	3	NH-SI 1 20A GL AG AC500V LI	<b>35203-0040</b>
NH-SI 1 25A GL AG AC500V LI	1	25	3	NH-SI 1 25A GL AG AC500V LI	<b>35203-0050</b>
NH-SI 1 35A GL AG AC500V LI	1	35	3	NH-SI 1 35A GL AG AC500V LI	<b>35203-0060</b>
NH-SI 1 50A GL AG AC500V LI	1	50	3	NH-SI 1 50A GL AG AC500V LI	<b>35203-0070</b>
NH-SI 1 63A GL AG AC500V LI	1	63	3	NH-SI 1 63A GL AG AC500V LI	<b>35203-0080</b>
NH-SI 1 80A GL AG AC500V LI	1	80	3	NH-SI 1 80A GL AG AC500V LI	<b>35203-0090</b>
NH-SI 1 100A GL AG AC500V LI	1	100	3	NH-SI 1 100A GL AG AC500V LI	<b>35203-0100</b>
NH-SI 1 125A GL AG AC500V LI	1	125	3	NH-SI 1 125A GL AG AC500V LI	<b>35203-0110</b>
NH-SI 1 160A GL AG AC500V LI	1	160	3	NH-SI 1 160A GL AG AC500V LI	<b>35203-0120</b>
NH-SI 1 200A GL AG AC500V LI	1	200	3	NH-SI 1 200A GL AG AC500V LI	<b>35203-0130</b>
NH-SI 1 224A GL AG AC500V LI	1	224	3	NH-SI 1 224A GL AG AC500V LI	<b>35203-0140</b>
NH-SI 1 250A GL AG AC500V LI	1	250	3	NH-SI 1 250A GL AG AC500V LI	<b>35203-0150</b>
NH-SI 2 25A GL AG AC500V LI	2	25	3	NH-SI 2 25A GL AG AC500V LI	<b>35115-0010</b>
NH-SI 2 35A GL AG AC500V LI	2	35	3	NH-SI 2 35A GL AG AC500V LI	<b>35115-0020</b>
NH-SI 2 50A GL AG AC500V LI	2	50	3	NH-SI 2 50A GL AG AC500V LI	<b>35115-0030</b>
NH-SI 2 63A GL AG AC500V LI	2	63	3	NH-SI 2 63A GL AG AC500V LI	<b>35115-0040</b>
NH-SI 2 80A GL AG AC500V LI	2	80	3	NH-SI 2 80A GL AG AC500V LI	<b>35115-0050</b>
NH-SI 2 100A GL AG AC500V LI	2	100	3	NH-SI 2 100A GL AG AC500V LI	<b>35115-0060</b>
NH-SI 2 125A GL AG AC500V LI	2	125	3	NH-SI 2 125A GL AG AC500V LI	<b>35115-0070</b>
NH-SI 2 160A GL AG AC500V LI	2	160	3	NH-SI 2 160A GL AG AC500V LI	<b>35115-0080</b>
NH-SI 2 200A GL AG AC500V LI	2	200	3	NH-SI 2 200A GL AG AC500V LI	<b>35115-0090</b>
NH-SI 2 224A GL AG AC500V LI	2	224	3	NH-SI 2 224A GL AG AC500V LI	<b>35115-0100</b>
NH-SI 2 250A GL AG AC500V LI	2	250	3	NH-SI 2 250A GL AG AC500V LI	<b>35115-0110</b>
NH-SI 2 300A GL AG AC500V LI	2	300	3	NH-SI 2 300A GL AG AC500V LI	<b>35115-0120</b>
NH-SI 2 315A GL AG AC500V LI	2	315	3	NH-SI 2 315A GL AG AC500V LI	<b>35115-0130</b>
NH-SI 2 355A GL AG AC500V LI	2	355	3	NH-SI 2 355A GL AG AC500V LI	<b>35115-0140</b>
NH-SI 2 400A GL AG AC500V LI	2	400	3	NH-SI 2 400A GL AG AC500V LI	<b>35115-0150</b>

## NH Fuse-Links 500V gL

- Rated voltage: AC 500V / DC 440V\*
- Utilization category: gL acc. to VDE 0636-21 and VDE 0636-1
- IEC 60269-2
- Breaking capacity AC: 120 kA
- Breaking capacity DC: see technical data

► Technical data, page 40



35164-0240

### NH Fuse-Links for cable and line protection, AC 500V gL

#### Features:

- Center indicator (specifically for meshed mains systems)
- Insulated metal gripping lug
- Pure silver fuse element

Designation	Size	Amps	PU	Product designation	Order no.
NH-SI 00 10A GL AG AC500V LI AU	00	10	10	NH-SI 00 10A GL AG AC500V LI AU	<b>35164-0270</b>
NH-SI 00 16A GL AG AC500V LI AU	00	16	10	NH-SI 00 16A GL AG AC500V LI AU	<b>35164-0260</b>
NH-SI 00 25A GL AG AC500V LI AU	00	25	10	NH-SI 00 25A GL AG AC500V LI AU	<b>35164-0250</b>
NH-SI 00 35A GL AG AC500V LI AU	00	35	10	NH-SI 00 35A GL AG AC500V LI AU	<b>35164-0170</b>
NH-SI 00 40A GL AG AC500V LI AU	00	40	10	NH-SI 00 40A GL AG AC500V LI AU	<b>35164-0180</b>
NH-SI 00 50A GL AG AC500V LI AU	00	50	10	NH-SI 00 50A GL AG AC500V LI AU	<b>35164-0190</b>
NH-SI 00 63A GL AG AC500V LI AU	00	63	10	NH-SI 00 63A GL AG AC500V LI AU	<b>35164-0200</b>
NH-SI 00 80A GL AG AC500V LI AU	00	80	10	NH-SI 00 80A GL AG AC500V LI AU	<b>35164-0210</b>
NH-SI 00 100A GL AG AC500V LI AU	00	100	10	NH-SI 00 100A GL AG AC500V LI AU	<b>35164-0220</b>
NH-SI 00 125A GL AG AC500V LI AU	00	125	10	NH-SI 00 125A GL AG AC500V LI AU	<b>35164-0230</b>
NH-SI 00 160A GL AG AC500V LI AU	00	160	10	NH-SI 00 160A GL AG AC500V LI AU	<b>35164-0240</b>
NH-SI 2 35A GL AG AC500V LI AU	2	35	3	NH-SI 2 35A GL AG AC500V LI AU	<b>35115-0280</b>
NH-SI 2 63A GL AG AC500V LI AU	2	63	3	NH-SI 2 63A GL AG AC500V LI AU	<b>35115-0160</b>
NH-SI 2 80A GL AG AC500V LI AU	2	80	3	NH-SI 2 80A GL AG AC500V LI AU	<b>35115-0170</b>
NH-SI 2 100A GL AG AC500V LI AU	2	100	3	NH-SI 2 100A GL AG AC500V LI AU	<b>35115-0180</b>
NH-SI 2 125A GL AG AC500V LI AU	2	125	3	NH-SI 2 125A GL AG AC500V LI AU	<b>35115-0190</b>
NH-SI 2 160A GL AG AC500V LI AU	2	160	3	NH-SI 2 160A GL AG AC500V LI AU	<b>35115-0200</b>
NH-SI 2 200A GL AG AC500V LI AU	2	200	3	NH-SI 2 200A GL AG AC500V LI AU	<b>35115-0210</b>
NH-SI 2 224A GL AG AC500V LI AU	2	224	3	NH-SI 2 224A GL AG AC500V LI AU	<b>35115-0220</b>
NH-SI 2 250A GL AG AC500V LI AU	2	250	3	NH-SI 2 250A GL AG AC500V LI AU	<b>35115-0230</b>
NH-SI 2 300A GL AG AC500V LI AU	2	300	3	NH-SI 2 300A GL AG AC500V LI AU	<b>35115-0240</b>
NH-SI 2 315A GL AG AC500V LI AU	2	315	3	NH-SI 2 315A GL AG AC500V LI AU	<b>35115-0250</b>
NH-SI 2 355A GL AG AC500V LI AU	2	355	3	NH-SI 2 355A GL AG AC500V LI AU	<b>35115-0260</b>
NH-SI 2 400A GL AG AC500V LI AU	2	400	3	NH-SI 2 400A GL AG AC500V LI AU	<b>35115-0270</b>

# NH Fuse-Links 690 V gG

- Rated voltage: AC 690 V
- Utilization category: gG acc. to VDE 0636-2 and VDE 0636-1
- IEC 60269-2 and IEC 60269-1
- Application: for cable and line protection
- Breaking capacity AC: 80 kA (630 A, 50 kA)
- Breaking capacity DC: see technical data

► Technical data, page 42



35421-0250

## NH Fuse-Links for cable and line protection, 690 V AC gG

### Features:

- Twin indicator
- Non-insulated metal gripping lug
- Copper fuse element

Designation	Size	Amps	PU	Product designation	Order no.
NH-SI 000 2A GG AC690V AK	000	2	3	NH-SI 000 2A GG AC690V AK	<b>35421-0020</b>
NH-SI 000 4A GG AC690V AK	000	4	3	NH-SI 000 4A GG AC690V AK	<b>35421-0040</b>
NH-SI 000 6A GG AC690V AK	000	6	3	NH-SI 000 6A GG AC690V AK	<b>35421-0060</b>
NH-SI 000 10A GG AC690V AK	000	10	3	NH-SI 000 10A GG AC690V AK	<b>35421-0100</b>
NH-SI 000 16A GG AC690V AK	000	16	3	NH-SI 000 16A GG AC690V AK	<b>35421-0160</b>
NH-SI 000 20A GG AC690V AK	000	20	3	NH-SI 000 20A GG AC690V AK	<b>35421-0200</b>
NH-SI 000 25A GG AC690V AK	000	25	3	NH-SI 000 25A GG AC690V AK	<b>35421-0250</b>
NH-SI 000 32A GG AC690V AK	000	32	3	NH-SI 000 32A GG AC690V AK	<b>35421-0320</b>
NH-SI 000 35A GG AC690V AK	000	35	3	NH-SI 000 35A GG AC690V AK	<b>35421-0350</b>
NH-SI 000 40A GG AC690V AK	000	40	3	NH-SI 000 40A GG AC690V AK	<b>35421-0400</b>
NH-SI 000 50A GG AC690V AK	000	50	3	NH-SI 000 50A GG AC690V AK	<b>35421-0500</b>
NH-SI 000 63A GG AC690V AK	000	63	3	NH-SI 000 63A GG AC690V AK	<b>35421-0630</b>
NH-SI 00 80A GG AC690V AK	00	80	3	NH-SI 00 80A GG AC690V AK	<b>35422-0800</b>
NH-SI 00 100A GG AC690V AK	00	100	3	NH-SI 00 100A GG AC690V AK	<b>35422-1000</b>
NH-SI 00 125A GG AC690V AK	00	125	3	NH-SI 00 125A GG AC690V AK	<b>35422-1250</b>
NH-SI 1/ 25A GG AC690V AK	1	25	3	NH-SI 1/ 25A GG AC690V AK	<b>35423-0250</b>
NH-SI 1/ 32A GG AC690V AK	1	32	3	NH-SI 1/ 32A GG AC690V AK	<b>35423-0320</b>
NH-SI 1/ 35A GG AC690V AK	1	35	3	NH-SI 1/ 35A GG AC690V AK	<b>35423-0350</b>
NH-SI 1/ 40A GG AC690V AK	1	40	3	NH-SI 1/ 40A GG AC690V AK	<b>35423-0400</b>
NH-SI 1/ 50A GG AC690V AK	1	50	3	NH-SI 1/ 50A GG AC690V AK	<b>35423-0500</b>
NH-SI 1/ 63A GG AC690V AK	1	63	3	NH-SI 1/ 63A GG AC690V AK	<b>35423-0630</b>
NH-SI 1/ 80A GG AC690V AK	1	80	3	NH-SI 1/ 80A GG AC690V AK	<b>35423-0800</b>
NH-SI 1/ 100A GG AC690V AK	1	100	3	NH-SI 1/ 100A GG AC690V AK	<b>35423-1000</b>
NH-SI 1 125A GG AC690V AK	1	125	3	NH-SI 1 125A GG AC690V AK	<b>35423-1250</b>
NH-SI 1 160A GG AC690V AK	1	160	3	NH-SI 1 160A GG AC690V AK	<b>35423-1600</b>
NH-SI 1 200A GG AC690V AK	1	200	3	NH-SI 1 200A GG AC690V AK	<b>35423-2000</b>
NH-SI 1 250A GG AC690V AK	1	250	3	NH-SI 1 250A GG AC690V AK	<b>35423-2500</b>
NH-SI 2/ 25A GG AC690V AK	2	25	3	NH-SI 2/ 25A GG AC690V AK	<b>35424-0250</b>
NH-SI 2/ 35A GG AC690V AK	2	35	3	NH-SI 2/ 35A GG AC690V AK	<b>35424-0350</b>
NH-SI 2/ 50A GG AC690V AK	2	50	3	NH-SI 2/ 50A GG AC690V AK	<b>35424-0500</b>
NH-SI 2/ 63A GG AC690V AK	2	63	3	NH-SI 2/ 63A GG AC690V AK	<b>35424-0630</b>
NH-SI 2/ 80A GG AC690V AK	2	80	3	NH-SI 2/ 80A GG AC690V AK	<b>35424-0800</b>
NH-SI 2/ 100A GG AC690V AK	2	100	3	NH-SI 2/ 100A GG AC690V AK	<b>35424-1000</b>
NH-SI 2/ 125A GG AC690V AK	2	125	3	NH-SI 2/ 125A GG AC690V AK	<b>35424-1250</b>
NH-SI 2/ 160A GG AC690V AK	2	160	3	NH-SI 2/ 160A GG AC690V AK	<b>35424-1600</b>
NH-SI 2/ 200A GG AC690V AK	2	200	3	NH-SI 2/ 200A GG AC690V AK	<b>35424-2000</b>
NH-SI 2/ 250A GG AC690V AK	2	250	3	NH-SI 2/ 250A GG AC690V AK	<b>35424-2500</b>
NH-SI 2 315A GG AC690V AK	2	315	3	NH-SI 2 315A GG AC690V AK	<b>35424-3150</b>
NH-SI 2 355A GG AC690V AK	2	355	3	NH-SI 2 355A GG AC690V AK	<b>35424-3550</b>
NH-SI 2 400A GG AC690V MA	2	400	3	NH-SI 2 400A GG AC690V MA	<b>35424-4000</b>

## NH Fuse-Links 690 V gG

- Rated voltage: AC 690 V
- Utilization category: gG acc. to VDE 0636-2 and VDE 0636-1
- IEC 60269-2 and IEC 60269-1
- Application: for cable and line protection
- Breaking capacity AC: 80 kA (630 A, 50 kA)
- Breaking capacity DC: see technical data

► Technical data, page 42



35425-4000

### NH Fuse-Links for cable and line protection, 690 V AC gG

**Features:**

- Twin indicator (630 A with center indicator)
- Non-insulated metal gripping lug
- Copper fuse element

Designation	Size	Amps	PU	Product designation	Order no.
NH-SI 3/ 80A GG AC690V AK	3	80	3	NH-SI 3/ 80A GG AC690V AK	<b>35425-0800</b>
NH-SI 3/ 100A GG AC690V AK	3	100	3	NH-SI 3/ 100A GG AC690V AK	<b>35425-1000</b>
NH-SI 3/ 125A GG AC690V AK	3	125	3	NH-SI 3/ 125A GG AC690V AK	<b>35425-1250</b>
NH-SI 3/ 160A GG AC690V AK	3	160	3	NH-SI 3/ 160A GG AC690V AK	<b>35425-1600</b>
NH-SI 3/ 200A GG AC690V AK	3	200	3	NH-SI 3/ 200A GG AC690V AK	<b>35425-2000</b>
NH-SI 3/ 224A GG AC690V AK	3	224	3	NH-SI 3/ 224A GG AC690V AK	<b>35425-2240</b>
NH-SI 3/ 250A GG AC690V AK	3	250	3	NH-SI 3/ 250A GG AC690V AK	<b>35425-2500</b>
NH-SI 3/ 315A GG AC690V AK	3	315	3	NH-SI 3/ 315A GG AC690V AK	<b>35425-3150</b>
NH-SI 3/ 355A GG AC690V AK	3	355	3	NH-SI 3/ 355A GG AC690V AK	<b>35425-3550</b>
NH-SI 3 400A GG AC690V AK	3	400	3	NH-SI 3 400A GG AC690V AK	<b>35425-4000</b>
NH-SI 3 425A GG AC690V AK	3	425	3	NH-SI 3 425A GG AC690V AK	<b>35425-4250</b>
NH-SI 3 500A GG AC690V AK	3	500	3	NH-SI 3 500A GG AC690V AK	<b>35425-5000</b>
NH-SI 3 630A GG AC690V MA	3	630	3	NH-SI 3 630A GG AC690V MA	<b>35425-6300</b>

# NH Fuse-Links 500 V gR

- Rated voltage: AC 500 V
- Utilization category: gR acc. to VDE 0636-4
- Application: for semiconductor protection
- Breaking capacity AC: 120 kA
- Breaking capacity DC: see technical data

► Technical data, page 46



35058-0110

## NH Fuse-Links for semiconductor protection, 500 V AC gR

### Features:

- Center indicator
- Non-insulated metal gripping lug
- Pure silver fuse element

Designation	Size	Amps	PU	Product designation	Order no.
NH-SI 00 16A GR AC500V LS	00	16	10	NH-SI 00 16A GR AC500V LS	35024-0180
NH-SI 00 20A GR AC500V LS	00	20	10	NH-SI 00 20A GR AC500V LS	35024-0170
NH-SI 00 25A GR AC500V LS	00	25	10	NH-SI 00 25A GR AC500V LS	35024-0190
NH-SI 00 35A GR AC500V LS	00	35	10	NH-SI 00 35A GR AC500V LS	35024-0010
NH-SI 00 40A GR AC500V LS	00	40	10	NH-SI 00 40A GR AC500V LS	35024-0020
NH-SI 00 50A GR AC500V LS	00	50	10	NH-SI 00 50A GR AC500V LS	35024-0030
NH-SI 00 63A GR AC500V LS	00	63	10	NH-SI 00 63A GR AC500V LS	35024-0040
NH-SI 00 80A GR AC500V LS	00	80	10	NH-SI 00 80A GR AC500V LS	35024-0050
NH-SI 00 100A GR AC500V LS	00	100	10	NH-SI 00 100A GR AC500V LS	35024-0060
NH-SI 00 125A GR AC500V LS	00	125	10	NH-SI 00 125A GR AC500V LS	35024-0070
NH-SI 00 160A GR AC500V LS	00	160	10	NH-SI 00 160A GR AC500V LS	35024-0080
NH-SI 1 35A GR AC500V LS	1	35	3	NH-SI 1 35A GR AC500V LS	35040-0010
NH-SI 1 50A GR AC500V LS	1	50	3	NH-SI 1 50A GR AC500V LS	35040-0020
NH-SI 1 63A GR AC500V LS	1	63	3	NH-SI 1 63A GR AC500V LS	35040-0030
NH-SI 1 80A GR AC500V LS	1	80	3	NH-SI 1 80A GR AC500V LS	35040-0040
NH-SI 1 100A GR AC500V LS	1	100	3	NH-SI 1 100A GR AC500V LS	35040-0050
NH-SI 1 125A GR AC500V LS	1	125	3	NH-SI 1 125A GR AC500V LS	35040-0060
NH-SI 1 160A GR AC500V LS	1	160	3	NH-SI 1 160A GR AC500V LS	35040-0070
NH-SI 1 200A GR AC500V LS	1	200	3	NH-SI 1 200A GR AC500V LS	35040-0080
NH-SI 1 224A GR AC500V LS	1	224	3	NH-SI 1 224A GR AC500V LS	35040-0090
NH-SI 1 250A GR AC500V LS	1	250	3	NH-SI 1 250A GR AC500V LS	35040-0100
NH-SI 2 80A GR AC500V LS	2	80	3	NH-SI 2 80A GR AC500V LS	35058-0010
NH-SI 2 100A GR AC500V LS	2	100	3	NH-SI 2 100A GR AC500V LS	35058-0020
NH-SI 2 125A GR AC500V LS	2	125	3	NH-SI 2 125A GR AC500V LS	35058-0030
NH-SI 2 160A GR AC500V LS	2	160	3	NH-SI 2 160A GR AC500V LS	35058-0040
NH-SI 2 200A GR AC500V LS	2	200	3	NH-SI 2 200A GR AC500V LS	35058-0050
NH-SI 2 224A GR AC500V LS	2	224	3	NH-SI 2 224A GR AC500V LS	35058-0060
NH-SI 2 250A GR AC500V LS	2	250	3	NH-SI 2 250A GR AC500V LS	35058-0070
NH-SI 2 300A GR AC500V LS	2	300	3	NH-SI 2 300A GR AC500V LS	35058-0080
NH-SI 2 315A GR AC500V LS	2	315	3	NH-SI 2 315A GR AC500V LS	35058-0090
NH-SI 2 355A GR AC500V LS	2	355	3	NH-SI 2 355A GR AC500V LS	35058-0100
NH-SI 2 400A GR AC500V LS	2	400	3	NH-SI 2 400A GR AC500V LS	35058-0110
NH-SI 3 315A GR AC500V LS	3	315	1	NH-SI 3 315A GR AC500V LS	35079-0010
NH-SI 3 355A GR AC500V LS	3	355	1	NH-SI 3 355A GR AC500V LS	35079-0020
NH-SI 3 400A GR AC500V LS	3	400	1	NH-SI 3 400A GR AC500V LS	35079-0030
NH-SI 3 425A GR AC500V LS	3	425	1	NH-SI 3 425A GR AC500V LS	35079-0040
NH-SI 3 500A GR AC500V LS	3	500	1	NH-SI 3 500A GR AC500V LS	35079-0050
NH-SI 3 630A GR AC500V LS	3	630	1	NH-SI 3 630A GR AC500V LS	35079-0060
NH-SI 00 16A GR AC500V SM	00	16	10	NH-SI 00 16A GR AC500V SM	35218-0010
NH-SI 00 20A GR AC500V SM	00	20	10	NH-SI 00 20A GR AC500V SM	35218-0020
NH-SI 00 25A GR AC500V SM	00	25	10	NH-SI 00 25A GR AC500V SM	35218-0030
NH-SI 00 35A GR AC500V SM	00	35	10	NH-SI 00 35A GR AC500V SM	35218-0040
NH-SI 00 40A GR AC500V SM	00	40	10	NH-SI 00 40A GR AC500V SM	35218-0050
NH-SI 00 50A GR AC500V SM	00	50	10	NH-SI 00 50A GR AC500V SM	35218-0060
NH-SI 00 63A GR AC500V SM	00	63	10	NH-SI 00 63A GR AC500V SM	35218-0070
NH-SI 00 80A GR AC500V SM	00	80	10	NH-SI 00 80A GR AC500V SM	35218-0080
NH-SI 00 100A GR AC500V SM	00	100	10	NH-SI 00 100A GR AC500V SM	35218-0090
NH-SI 00 125A GR AC500V SM	00	125	10	NH-SI 00 125A GR AC500V SM	35218-0100
NH-SI 1 35A GR AC500V LS SM	1	35	1	NH-SI 1 35A GR AC500V LS SM	35046-0010
NH-SI 1 50A GR AC500V LS SM	1	50	1	NH-SI 1 50A GR AC500V LS SM	35046-0020
NH-SI 1 63A GR AC500V LS SM	1	63	1	NH-SI 1 63A GR AC500V LS SM	35046-0030
NH-SI 1 80A GR AC500V LS SM	1	80	1	NH-SI 1 80A GR AC500V LS SM	35046-0040
NH-SI 1 100A GR AC500V LS SM	1	100	1	NH-SI 1 100A GR AC500V LS SM	35046-0050

## NH Fuse-Links 500 V gR

- Rated voltage: AC 500 V
- Utilization category: gR acc. to VDE 0636-4
- Application: for semiconductor protection
- Breaking capacity AC: 120 kA
- Breaking capacity DC: see technical data

► Technical data, page 46



35060-0150

### NH Fuse-Links for semiconductor protection, 500 V AC gR

**Features:**

- Center indicator
- Non-insulated metal gripping lug
- Pure silver fuse element
- Striker for fuse monitoring

Designation	Size	Amps	PU	Product designation	Order no.
NH-SI 00 16A GR AC500V SM	00	16	10	NH-SI 00 16A GR AC500V SM	<b>35218-0010</b>
NH-SI 00 20A GR AC500V SM	00	20	10	NH-SI 00 20A GR AC500V SM	<b>35218-0020</b>
NH-SI 00 25A GR AC500V SM	00	25	10	NH-SI 00 25A GR AC500V SM	<b>35218-0030</b>
NH-SI 00 35A GR AC500V SM	00	35	10	NH-SI 00 35A GR AC500V SM	<b>35218-0040</b>
NH-SI 00 40A GR AC500V SM	00	40	10	NH-SI 00 40A GR AC500V SM	<b>35218-0050</b>
NH-SI 00 50A GR AC500V SM	00	50	10	NH-SI 00 50A GR AC500V SM	<b>35218-0060</b>
NH-SI 00 63A GR AC500V SM	00	63	10	NH-SI 00 63A GR AC500V SM	<b>35218-0070</b>
NH-SI 00 80A GR AC500V SM	00	80	10	NH-SI 00 80A GR AC500V SM	<b>35218-0080</b>
NH-SI 00 100A GR AC500V SM	00	100	10	NH-SI 00 100A GR AC500V SM	<b>35218-0090</b>
NH-SI 00 125A GR AC500V SM	00	125	10	NH-SI 00 125A GR AC500V SM	<b>35218-0100</b>
NH-SI 1 35A GR AC500V LS SM	1	35	1	NH-SI 1 35A GR AC500V LS SM	<b>35046-0010</b>
NH-SI 1 50A GR AC500V LS SM	1	50	1	NH-SI 1 50A GR AC500V LS SM	<b>35046-0020</b>
NH-SI 1 63A GR AC500V LS SM	1	63	1	NH-SI 1 63A GR AC500V LS SM	<b>35046-0030</b>
NH-SI 1 80A GR AC500V LS SM	1	80	1	NH-SI 1 80A GR AC500V LS SM	<b>35046-0040</b>
NH-SI 1 100A GR AC500V LS SM	1	100	1	NH-SI 1 100A GR AC500V LS SM	<b>35046-0050</b>
NH-SI 1 160A GR AC500V LS SM	1	160	1	NH-SI 1 160A GR AC500V LS SM	<b>35046-0070</b>
NH-SI 1 200A GR AC500V LS SM	1	200	1	NH-SI 1 200A GR AC500V LS SM	<b>35046-0080</b>
NH-SI 1 224A GR AC500V LS SM	1	224	1	NH-SI 1 224A GR AC500V LS SM	<b>35046-0090</b>
NH-SI 1 250A GR AC500V LS SM	1	250	1	NH-SI 1 250A GR AC500V LS SM	<b>35046-0100</b>
NH-SI 2 80A GR AC500V LS SM	2	80	1	NH-SI 2 80A GR AC500V LS SM	<b>35060-0050</b>
NH-SI 2 100A GR AC500V LS SM	2	100	1	NH-SI 2 100A GR AC500V LS SM	<b>35060-0060</b>
NH-SI 2 125A GR AC500V LS SM	2	125	1	NH-SI 2 125A GR AC500V LS SM	<b>35060-0070</b>
NH-SI 2 160A GR AC500V LS SM	2	160	1	NH-SI 2 160A GR AC500V LS SM	<b>35060-0080</b>
NH-SI 2 200A GR AC500V LS SM	2	200	1	NH-SI 2 200A GR AC500V LS SM	<b>35060-0090</b>
NH-SI 2 224A GR AC500V LS SM	2	224	1	NH-SI 2 224A GR AC500V LS SM	<b>35060-0100</b>
NH-SI 2 250A GR AC500V LS SM	2	250	1	NH-SI 2 250A GR AC500V LS SM	<b>35060-0110</b>
NH-SI 2 300A GR AC500V LS SM	2	300	1	NH-SI 2 300A GR AC500V LS SM	<b>35060-0120</b>
NH-SI 2 315A GR AC500V LS SM	2	315	1	NH-SI 2 315A GR AC500V LS SM	<b>35060-0130</b>
NH-SI 2 355A GR AC500V LS SM	2	355	1	NH-SI 2 355A GR AC500V LS SM	<b>35060-0140</b>
NH-SI 2 400A GR AC500V LS SM	2	400	1	NH-SI 2 400A GR AC500V LS SM	<b>35060-0150</b>
NH-SI 3 315A GR AC500V LS SM	3	315	1	NH-SI 3 315A GR AC500V LS SM	<b>35086-0010</b>
NH-SI 3 355A GR AC500V LS SM	3	355	1	NH-SI 3 355A GR AC500V LS SM	<b>35086-0020</b>
NH-SI 3 400A GR AC500V LS SM	3	400	1	NH-SI 3 400A GR AC500V LS SM	<b>35086-0030</b>
NH-SI 3 425A GR AC500V LS SM	3	425	1	NH-SI 3 425A GR AC500V LS SM	<b>35086-0040</b>
NH-SI 3 500A GR AC500V LS SM	3	500	1	NH-SI 3 500A GR AC500V LS SM	<b>35086-0050</b>
NH-SI 3 630A GR AC500V LS SM	3	630	1	NH-SI 3 630A GR AC500V LS SM	<b>35086-0060</b>

# NH Fuse-Links 500V gR

- Rated voltage: AC 500 V
- Utilization category: gR acc. to VDE 0636-4
- Application: Maintenance fuse
- Breaking capacity AC: 120 kA

► Technical data, page 50



35209-0050

## Maintenance fuse-link 500 V AC LI

### Features:

- Specific marking
- Insulated metal gripping lugs
- Pure silver fuse element
- Highly vibration-resistant screws

Designation	Size	Amps	PU	Product designation	Order no.
NH-ARBEITSSICHERUNG 2 80A GR AC500V LI	2	80	3	NH-ARBEITSSICHERUNG 2 80A GR AC500V LI	<b>35209-0010</b>
NH-ARBEITSSICHERUNG 2 100A GR AC500V LI	2	100	3	NH-ARBEITSSICHERUNG 2 100A GR AC500V LI	<b>35209-0020</b>
NH-ARBEITSSICHERUNG 2 125A GR AC500V LI	2	125	3	NH-ARBEITSSICHERUNG 2 125A GR AC500V LI	<b>35209-0030</b>
NH-ARBEITSSICHERUNG 2 160A GR AC500V LI	2	160	3	NH-ARBEITSSICHERUNG 2 160A GR AC500V LI	<b>35209-0040</b>
NH-ARBEITSSICHERUNG 2 200A GR AC500V LI	2	200	3	NH-ARBEITSSICHERUNG 2 200A GR AC500V LI	<b>35209-0050</b>
NH-ARBEITSSICHERUNG 2 224A GR AC500V LI	2	224	3	NH-ARBEITSSICHERUNG 2 224A GR AC500V LI	<b>35209-0060</b>
NH-ARBEITSSICHERUNG 2 250A GR AC500V LI	2	250	3	NH-ARBEITSSICHERUNG 2 250A GR AC500V LI	<b>35209-0070</b>
NH-ARBEITSSICHERUNG 2 300A GR AC500V LI	2	300	3	NH-ARBEITSSICHERUNG 2 300A GR AC500V LI	<b>35209-0080</b>
NH-ARBEITSSICHERUNG 2 315A GR AC500V LI	2	315	3	NH-ARBEITSSICHERUNG 2 315A GR AC500V LI	<b>35209-0090</b>

## NH Fuse-Links 400 V gTr

- Rated voltage: 400 V AC gTr
- Utilization category: gTr acc. to VDE 0636-2011
- Application: for transformer protection
- Breaking capacity: 100 kA size 3, 630 kVA, 50 kA

► Technical data, page 44



35081-0110

### NH Fuse-Links for transformer protection, 400 V AC gTr

#### Features:

- Center indicator
- Non-insulated metal gripping lug
- Copper fuse element

Designation	Size	kVA	Amps	PU	Product designation	Order no.
NH-SI 2 50KVA GTR AC400V MA	2	50	72	3	NH-SI 2 50KVA GTR AC400V MA	<b>35076-1010</b>
NH-SI 2 75KVA GTR AC400V MA	2	75	108	3	NH-SI 2 75KVA GTR AC400V MA	<b>35076-1020</b>
NH-SI 2 100KVA GTR AC400V MA	2	100	144	3	NH-SI 2 100KVA GTR AC400V MA	<b>35076-1030</b>
NH-SI 2 125KVA GTR AC400V MA	2	125	180	3	NH-SI 2 125KVA GTR AC400V MA	<b>35076-1040</b>
NH-SI 2 160KVA GTR AC400V MA	2	160	231	3	NH-SI 2 160KVA GTR AC400V MA	<b>35076-1050</b>
NH-SI 2 200KVA GTR AC400V MA	2	200	289	3	NH-SI 2 200KVA GTR AC400V MA	<b>35076-1060</b>
NH-SI 2 250KVA GTR AC400V MA	2	250	361	3	NH-SI 2 250KVA GTR AC400V MA	<b>35076-1070</b>
NH-SI 3 100KVA GTR AC400V MA	3	100	144	1	NH-SI 3 100KVA GTR AC400V MA	<b>35081-1040</b>
NH-SI 3 160KVA GTR AC400V MA	3	160	231	1	NH-SI 3 160KVA GTR AC400V MA	<b>35081-1060</b>
NH-SI 3 200KVA GTR AC400V MA	3	200	289	1	NH-SI 3 200KVA GTR AC400V MA	<b>35081-1050</b>
NH-SI 3 250KVA GTR AC400V MA	3	250	361	1	NH-SI 3 250KVA GTR AC400V MA	<b>35081-1010</b>
NH-SI 3 315KVA GTR AC400V MA	3	315	455	1	NH-SI 3 315KVA GTR AC400V MA	<b>35081-1020</b>
NH-SI 3 400KVA GTR AC400V MA	3	400	577	1	NH-SI 3 400KVA GTR AC400V MA	<b>35081-1030</b>
NH-SI 3 500KVA GTR AC400V MA	3	500	722	1	NH-SI 3 500KVA GTR AC400V MA	<b>35081-0100</b>
NH-SI 3 630KVA GTR AC400V MA	3	630	909	1	NH-SI 3 630KVA GTR AC400V MA	<b>35081-0110</b>
NH-SI 4A 100KVA GTR AC400V MA	4a	100	144	1	NH-SI 4A 100KVA GTR AC400V MA	<b>35100-0100</b>
NH-SI 4A 160KVA GTR AC400V MA	4a	160	231	1	NH-SI 4A 160KVA GTR AC400V MA	<b>35100-0110</b>
NH-SI 4A 200KVA GTR AC400V MA	4a	200	289	1	NH-SI 4A 200KVA GTR AC400V MA	<b>35100-0160</b>
NH-SI 4A 250KVA GTR AC400V MA	4a	250	361	1	NH-SI 4A 250KVA GTR AC400V MA	<b>35100-0120</b>
NH-SI 4A 315KVA GTR AC400V MA	4a	315	455	1	NH-SI 4A 315KVA GTR AC400V MA	<b>35100-0170</b>
NH-SI 4A 400KVA GTR AC400V MA	4a	400	577	1	NH-SI 4A 400KVA GTR AC400V MA	<b>35100-0130</b>
NH-SI 4A 500KVA GTR AC400V MA	4a	500	722	1	NH-SI 4A 500KVA GTR AC400V MA	<b>35100-0140</b>
NH-SI 4A 630KVA GTR AC400V MA	4a	630	909	1	NH-SI 4A 630KVA GTR AC400V MA	<b>35100-0150</b>
NH-SI 4A 800KVA GTR AC400V MA	4a	800	1155	1	NH-SI 4A 800KVA GTR AC400V MA	<b>35100-0040</b>
NH-SI 4A 1000KVA GTR AC400V	4a	1000	1443	1	NH-SI 4A 1000KVA GTR AC400V	<b>35100-0190</b>

# NH Fuse-Links 1000 V gB/aM

► Technical data, page 49



35041-0180

## NH Fuse-Links 1L, 1000 V gB

### Features:

- AC 1000 V / DC 550 V\*
- Breaking capacity: 25 kA
- gB acc. to VDE 0636-2011

Designation	Size	Amps	PU	Product designation	Order no.
NH-SI 1L 10A GB AC1000V LS AS	1L	10	1	NH-SI 1L 10A GB AC1000V LS AS	<b>35041-0410</b>
NH-SI 1L 16A GB AC1000V LS AS	1L	16	1	NH-SI 1L 16A GB AC1000V LS AS	<b>35041-0420</b>
NH-SI 1L 35A GB AC1000V LS AS	1L	35	1	NH-SI 1L 35A GB AC1000V LS AS	<b>35041-0100</b>
NH-SI 1L 50A GB AC1000V LS AS	1L	50	1	NH-SI 1L 50A GB AC1000V LS AS	<b>35041-0110</b>
NH-SI 1L 63A GB AC1000V LS AS	1L	63	1	NH-SI 1L 63A GB AC1000V LS AS	<b>35041-0120</b>
NH-SI 1L 80A GB AC1000V LS AS	1L	80	1	NH-SI 1L 80A GB AC1000V LS AS	<b>35041-0130</b>
NH-SI 1L 100A GB AC1000V LS AS	1L	100	1	NH-SI 1L 100A GB AC1000V LS AS	<b>35041-0140</b>
NH-SI 1L 125A GB AC1000V LS AS	1L	125	1	NH-SI 1L 125A GB AC1000V LS AS	<b>35041-0150</b>
NH-SI 1L 160A GB AC1000V LS AS	1L	160	1	NH-SI 1L 160A GB AC1000V LS AS	<b>35041-0160</b>
NH-SI 1L 200A GB AC1000V LS AS	1L	200	1	NH-SI 1L 200A GB AC1000V LS AS	<b>35041-0170</b>
NH-SI 1L 250A GB AC1000V LS AS	1L	250	1	NH-SI 1L 250A GB AC1000V LS AS	<b>35041-0180</b>



35151-0020

## NH Fuse-Links for the back-up protection of mining equipment

### Features:

- 1000 V AC (425 – 500 A) and 1500 V AC (10 – 355 A)
- Breaking capacity: 25 kA
- aM acc. to VDE 0636-2011

Designation	Size	Amps	PU	Product designation	Order no.
NH-SI 3 125A AM AC1000V SBW	3	125	1	NH-SI 3 125A AM AC1000V SBW	<b>35151-0010</b>
NH-SI 3 160A AM AC1000V SBW	3	160	1	NH-SI 3 160A AM AC1000V SBW	<b>35151-0020</b>
NH-SI 3 200A AM AC1000V SBW	3	200	1	NH-SI 3 200A AM AC1000V SBW	<b>35151-0030</b>
NH-SI 3 224A AM AC1000V SBW	3	224	1	NH-SI 3 224A AM AC1000V SBW	<b>35151-0040</b>
NH-SI 3 250A AM AC1000V SBW	3	250	1	NH-SI 3 250A AM AC1000V SBW	<b>35151-0050</b>
NH-SI 3 315A AM AC1000V SBW	3	315	1	NH-SI 3 315A AM AC1000V SBW	<b>35151-0070</b>
NH-SI 3 355A AM AC1000V SBW	3	355	1	NH-SI 3 355A AM AC1000V SBW	<b>35151-0080</b>
NH-SI 3 500A AM AC1000V SBW	3	500	1	NH-SI 3 500A AM AC1000V SBW	<b>35151-0120</b>

## NH Fuse-Links 1000 V / 1500 V TF

► Technical data, page 49



35150-0180

**NH Fuse-Links for the back-up protection of mining equipment**
**Features:**

- AC 1000 V
- Breaking capacity: 25 kA
- TF acc. to VDE 0660 and DIN 43620-5

Designation	Size	Amps	PU	Product designation	Order no.
NH-SI 3 10A TF AC1000V RHB	3	10	1	NH-SI 3 10A TF AC1000V RHB	<b>35150-0010</b>
NH-SI 3 16A TF AC1000V RHB	3	16	1	NH-SI 3 16A TF AC1000V RHB	<b>35150-0020</b>
NH-SI 3 20A TF AC1000V RHB	3	20	1	NH-SI 3 20A TF AC1000V RHB	<b>35150-0030</b>
NH-SI 3 25A TF AC1000V RHB	3	25	1	NH-SI 3 25A TF AC1000V RHB	<b>35150-0040</b>
NH-SI 3 35A TF AC1000V RHB	3	35	1	NH-SI 3 35A TF AC1000V RHB	<b>35150-0050</b>
NH-SI 3 50A TF AC1000V RHB	3	50	1	NH-SI 3 50A TF AC1000V RHB	<b>35150-0060</b>
NH-SI 3 63A TF AC1000V RHB	3	63	1	NH-SI 3 63A TF AC1000V RHB	<b>35150-0070</b>
NH-SI 3 80A TF AC1000V RHB	3	80	1	NH-SI 3 80A TF AC1000V RHB	<b>35150-0080</b>
NH-SI 3 100A TF AC1000V RHB	3	100	1	NH-SI 3 100A TF AC1000V RHB	<b>35150-0090</b>
NH-SI 3 125A TF AC1000V RHB	3	125	1	NH-SI 3 125A TF AC1000V RHB	<b>35150-0100</b>
NH-SI 3 160A TF AC1000V RHB	3	160	1	NH-SI 3 160A TF AC1000V RHB	<b>35150-0110</b>
NH-SI 3 200A TF AC1000V RHB	3	200	1	NH-SI 3 200A TF AC1000V RHB	<b>35150-0120</b>
NH-SI 3 224A TF AC1000V RHB	3	224	1	NH-SI 3 224A TF AC1000V RHB	<b>35150-0130</b>
NH-SI 3 250A TF AC1000V RHB	3	250	1	NH-SI 3 250A TF AC1000V RHB	<b>35150-0140</b>
NH-SI 3 300A TF AC1000V RHB	3	300	1	NH-SI 3 300A TF AC1000V RHB	<b>35150-0150</b>
NH-SI 3 315A TF AC1000V RHB	3	315	1	NH-SI 3 315A TF AC1000V RHB	<b>35150-0160</b>
NH-SI 3 355A TF AC1000V RHB	3	355	1	NH-SI 3 355A TF AC1000V RHB	<b>35150-0170</b>
NH-SI 3 425A TF AC1000V RHB	3	425	1	NH-SI 3 425A TF AC1000V RHB	<b>35150-0180</b>
NH-SI 3 400A TF AC1000V RHB	3	400	1	NH-SI 3 400A TF AC1000V RHB	<b>35150-0190</b>



35089-0190

**NH Fuse-Links, size 3L, special design**
**Features:**

- AC 1000 V (425 – 500 A), AC 1500 V (6 – 355 A)
- Breaking capacity: 10 kA
- TF acc. to VDE 0660 and DIN 43620-5

Designation	Size	Amps	PU	Product designation	Order no.
NH-SI 3L 6A TF AC1500V LS	3L	6	1	NH-SI 3L 6A TF AC1500V LS	<b>35089-0200</b>
NH-SI 3L 10A TF AC1500V LS	3L	10	1	NH-SI 3L 10A TF AC1500V LS	<b>35089-0010</b>
NH-SI 3L 16A TF AC1500V LS	3L	16	1	NH-SI 3L 16A TF AC1500V LS	<b>35089-0020</b>
NH-SI 3L 20A TF AC1500V LS	3L	20	1	NH-SI 3L 20A TF AC1500V LS	<b>35089-0030</b>
NH-SI 3L 25A TF AC1500V LS	3L	25	1	NH-SI 3L 25A TF AC1500V LS	<b>35089-0040</b>
NH-SI 3L 35A TF AC1500V LS	3L	35	1	NH-SI 3L 35A TF AC1500V LS	<b>35089-0050</b>
NH-SI 3L 50A TF AC1500V LS	3L	50	1	NH-SI 3L 50A TF AC1500V LS	<b>35089-0060</b>
NH-SI 3L 63A TF AC1500V LS	3L	63	1	NH-SI 3L 63A TF AC1500V LS	<b>35089-0070</b>
NH-SI 3L 80A TF AC1500V LS	3L	80	1	NH-SI 3L 80A TF AC1500V LS	<b>35089-0080</b>
NH-SI 3L 100A TF AC1500V LS	3L	100	1	NH-SI 3L 100A TF AC1500V LS	<b>35089-0090</b>
NH-SI 3L 125A TF AC1500V LS	3L	125	1	NH-SI 3L 125A TF AC1500V LS	<b>35089-0100</b>
NH-SI 3L 160A TF AC1500V LS	3L	160	1	NH-SI 3L 160A TF AC1500V LS	<b>35089-0110</b>
NH-SI 3L 200A TF AC1500V LS	3L	200	1	NH-SI 3L 200A TF AC1500V LS	<b>35089-0120</b>
NH-SI 3L 224A TF AC1500V LS	3L	224	1	NH-SI 3L 224A TF AC1500V LS	<b>35089-0130</b>
NH-SI 3L 250A TF AC1500V LS	3L	250	1	NH-SI 3L 250A TF AC1500V LS	<b>35089-0140</b>
NH-SI 3L 300A TF AC1500V LS	3L	300	1	NH-SI 3L 300A TF AC1500V LS	<b>35089-0150</b>
NH-SI 3L 315A TF AC1500V LS	3L	315	1	NH-SI 3L 315A TF AC1500V LS	<b>35089-0160</b>
NH-SI 3L 355A TF AC1500V LS	3L	355	1	NH-SI 3L 355A TF AC1500V LS	<b>35089-0170</b>
NH-SI 3L 425A TF AC1000V LS	3L	425	1	NH-SI 3L 425A TF AC1000V LS	<b>35089-0180</b>
NH-SI 3L 500A TF AC1000V LS	3L	500	1	NH-SI 3L 500A TF AC1000V LS	<b>35089-0190</b>

# NH Fuse-Links 1000 V / 1500 V TF

► Technical data, page 49



35091-0190

## NH Fuse-Links, size 3L, special design

### Features:

- 1000 V AC (425 – 500 A) and 1500 V AC (10 – 355 A)
- 10 kA (1500 V AC)/50 kA (1000 V DC)
- TF acc. to VDE 0660 and DIN 43620-5
- Striker pin for fuse monitoring

Designation	Size	Amps	PU	Product designation	Order no.
NH-SI 3L 10A TF AC1500V SM	3L	10	1	NH-SI 3L 10A TF AC1500V SM	<b>35091-0010</b>
NH-SI 3L 16A TF AC1500V SM	3L	16	1	NH-SI 3L 16A TF AC1500V SM	<b>35091-0020</b>
NH-SI 3L 20A TF AC1500V SM	3L	20	1	NH-SI 3L 20A TF AC1500V SM	<b>35091-0030</b>
NH-SI 3L 25A TF AC1500V SM	3L	25	1	NH-SI 3L 25A TF AC1500V SM	<b>35091-0040</b>
NH-SI 3L 35A TF AC1500V SM	3L	35	1	NH-SI 3L 35A TF AC1500V SM	<b>35091-0050</b>
NH-SI 3L 50A TF AC1500V SM	3L	50	1	NH-SI 3L 50A TF AC1500V SM	<b>35091-0060</b>
NH-SI 3L 63A TF AC1500V SM	3L	63	1	NH-SI 3L 63A TF AC1500V SM	<b>35091-0070</b>
NH-SI 3L 80A TF AC1500V SM	3L	80	1	A NH-SI 3L 80A TF AC1500V SM	<b>35091-0080</b>
NH-SI 3L 100A TF AC1500V SM	3L	100	1	NH-SI 3L 100A TF AC1500V SM	<b>35091-0090</b>
NH-SI 3L 125A TF AC1500V SM	3L	125	1	NH-SI 3L 125A TF AC1500V SM	<b>35091-0100</b>
NH-SI 3L 160A TF AC1500V SM	3L	160	1	A NH-SI 3L 160A TF AC1500V SM	<b>35091-0110</b>
NH-SI 3L 200A TF AC1500V SM	3L	200	1	NH-SI 3L 200A TF AC1500V SM	<b>35091-0120</b>
NH-SI 3L 224A TF AC1500V SM	3L	224	1	NH-SI 3L 224A TF AC1500V SM	<b>35091-0130</b>
NH-SI 3L 250A TF AC1500V SM	3L	250	1	NH-SI 3L 250A TF AC1500V SM	<b>35091-0140</b>
NH-SI 3L 300A TF AC1500V SM	3L	300	1	NH-SI 3L 300A TF AC1500V SM	<b>35091-0150</b>
NH-SI 3L 315A TF AC1500V SM	3L	315	1	NH-SI 3L 315A TF AC1500V SM	<b>35091-0160</b>
NH-SI 3L 355A TF AC1500V SM	3L	355	1	NH-SI 3L 355A TF AC1500V SM	<b>35091-0170</b>
NH-SI 3L 425A TF AC1000V SM	3L	425	1	A NH-SI 3L 425A TF AC1000V SM	<b>35091-0180</b>
NH-SI 3L 500A TF AC1000V SM	3L	500	1	A NH-SI 3L 500A TF AC1000V SM	<b>35091-0190</b>

## NH Fuse-Links AC 400 V gG

In energy distribution, there is an ever increasing trend toward higher energy density. The number of distribution components such as circuit breakers, fuse switches, fuse bases increases while the size of cabinets keeps becoming even more compact. However, any cabinet can only handle a limited amount of power but also represents a major cost factor. The main application in energy distribution grids is the 230/400-V range.

Thanks to their significantly lower power dissipation, EFEN's 400-V fuse-links are optimally suited for the requirements of today and also save energy. The twin indicator ensures optimal visibility of the fuse status in all installations.

- Energy-saving design with 400-V fuse element
- Reduced power and heat dissipation
- Twin indicator ensures visibility in all installations

Power dissipation of 400 V and 500 V NH Fuse-Links compared

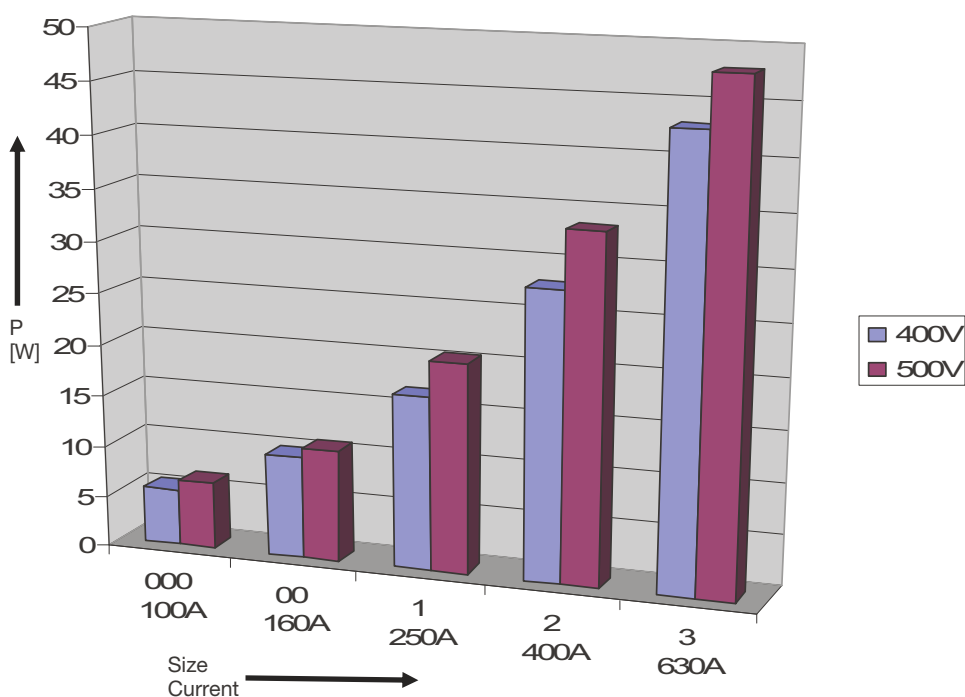

Annual power saving per fuse-link\*

Size	E
Current	[kWh]
NH 000 100A	2,6
NH 00 160A	2,9
NH 1 250A	9,2
NH 2 400A	14,5
NH 3 630A	13,1

\* 80% I<sub>n</sub> / ½ time

# NH Fuse-Links AC 400 V gG

Size	Amps	PU	Non-insulated metal gripping lugs Order no.	Insulated metal gripping lugs Order no.
000	2	3	35401-0020	35406-0020
000	4	3	35401-0040	35406-0040
000	6	3	35401-0060	35406-0060
000	10	3	35401-0100	35406-0100
000	16	3	35401-0160	35406-0160
000	20	3	35401-0200	35406-0200
000	25	3	35401-0250	35406-0250
000	32	3	35401-0320	35406-0320
000	35	3	35401-0350	35406-0350
000	40	3	35401-0400	35406-0400
000	50	3	35401-0500	35406-0500
000	63	3	35401-0630	35406-0630
000	80	3	35401-0800	35406-0800
000	100	3	35401-1000	35406-1000
00	125	3	35402-1250	35407-1250
00	160	3	35402-1600	35407-1600
1	16	3	35403-0160	35408-0160
1	20	3	35403-0200	35408-0200
1	25	3	35403-0250	35408-0250
1	32	3	35403-0320	35408-0320
1	35	3	35403-0350	35408-0350
1	40	3	35403-0400	35408-0400
1	50	3	35403-0500	35408-0500
1	63	3	35403-0630	35408-0630
1	80	3	35403-0800	35408-0800
1	100	3	35403-1000	35408-1000
1	125	3	35403-1250	35408-1250
1	160	3	35403-1600	35408-1600
1	200	3	35403-2000	35408-2000
1	224	3	35403-2240	35408-2240
1	250	3	35403-2500	35408-2500
2	35	3	35404-0350	35409-0350
2	50	3	35404-0500	35409-0500
2	63	3	35404-0630	35409-0630
2	80	3	35404-0800	35409-0800
2	100	3	35404-1000	35409-1000
2	125	3	35404-1250	35409-1250
2	160	3	35404-1600	35409-1600
2	200	3	35404-2000	35409-2000
2	224	3	35404-2240	35409-2240
2	250	3	35404-2500	35409-2500
2	315	3	35404-3150	35409-3150
2	355	3	35404-3550	35409-3550
2	400	3	35404-4000	35409-4000
3	250	1	35405-2500	35410-2500
3	300	1	35405-3000	35410-3000
3	315	1	35405-3150	35410-3150
3	400	1	35405-4000	35410-4000
3	425	1	35405-4250	35410-4250
3	500	1	35405-5000	35410-5000
3	630	1	35405-6300	35410-6300

For cable and line protection  
 Rated voltage: AC 400V  
 Utilization category: gG acc. to VDE 0636-2 and VDE 60269-2  
 Application: For cable and line protection  
 Breaking capacity: 100 kA

# NH Fuse-Links AC 400V gG

Fuse-Links

Time-current characteristics NH Fuse-Links of size 000 – 3, gG, 400 V AC, VDE 0636 part 2 and IEC 60269-2

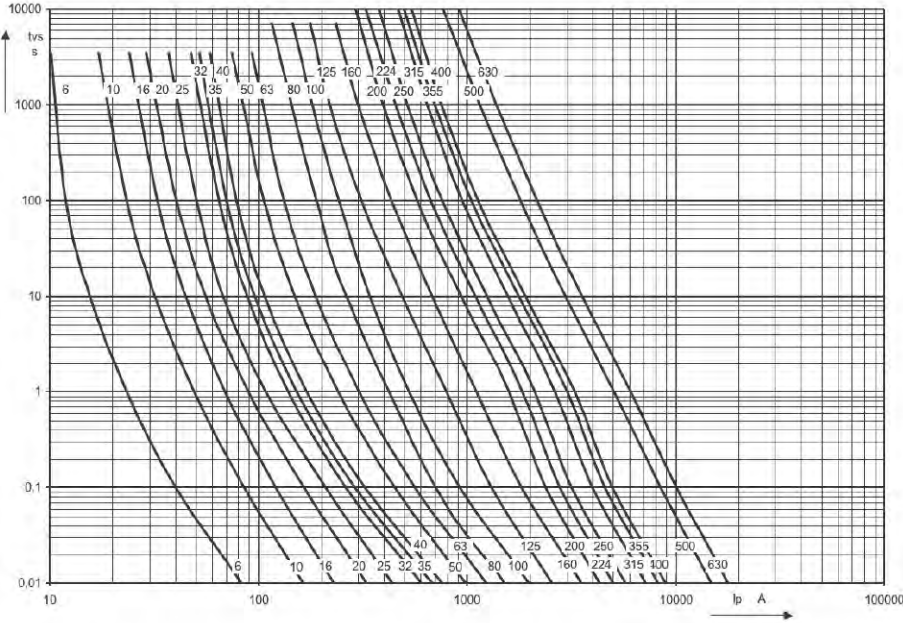

Cut-out current characteristics NH Fuse-Links size 000 – 3, gG, 400 V AC, VDE 0636 part 2 and IEC 60269-2

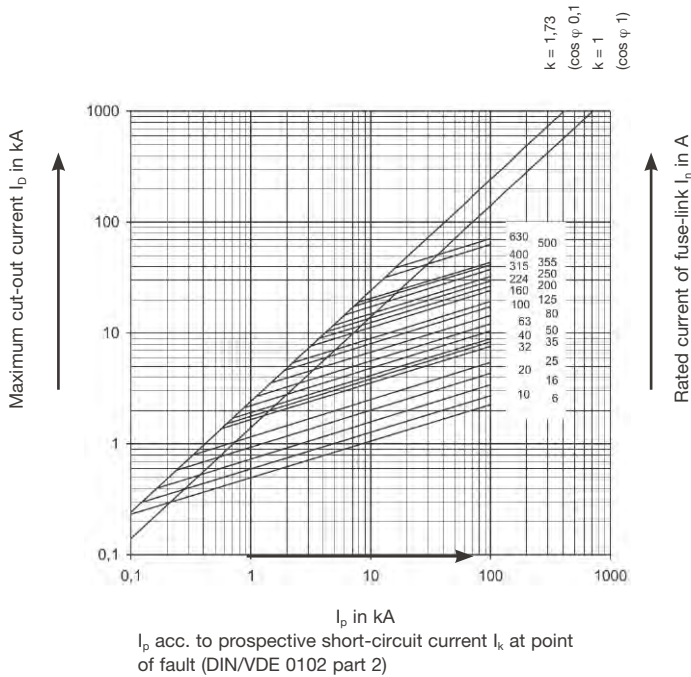

# NH Fuse-Links AC 400V gG

Rated power dissipation  $P_a$  in Watts of NH Fuse-Links size 000 – 3, gG, AC 400 V, acc. to VDE 0636 part 2 and IEC 60269-2

$I_n$ A	Size				
	000	00	1	2	3
6	1,7				
10	1,0				
16	1,8				
20	2,0				
25	2,4				
32	2,6				
35	3,2				
40	3,1				
50	3,5		4,5		
63	4,5	4,5	5,7		
80	5,0	5,0	5,5		
100	5,5	5,5	7,0	7,3	
125		8,6	9,1	9,1	
160		9,6	13,0	13,0	
200			13,1	13,5	
224			15,1	15,1	
250			16,9	18,0	
315				19,9	22,7
355				22,7	28,0
400				28,0	
500					30,8
630					43,0

Pre-arcing integrals and operating integrals in A<sup>2</sup>s NH Fuse-Links size 000 – 3, gG, AC 400 V, acc. to VDE 0636 part 2 and IEC 60269-2

$I_n$ A	Size									
	000		00		1		2		3	
	Pre-arcing	Operating	Pre-arcing	Operating	Pre-arcing	Operating	Pre-arcing	Operating	Pre-arcing	Operating
6	53	160								
10	115	570								
16	220	1 150								
20	455	2 400								
25	880	3 700								
32	2 450	9 000								
35	3 150	11 500			3 150	11 500	3 150	11 500		
40	3 950	14 000			3 950	14 000	-	-		
50	6 450	22 500			6 450	22 500	6 450	22 500		
63	9 950	35 500	9 950	35 500	9 950	35 500	9 950	35 500		
80	16 950	59 500	16 950	59 500	16 950	59 500	16 950	59 500		
100	28 500	100 300	28 500	100 300	28 500	100 300	28 500	100 300		
125			38 500	139 500	38 500	139 500	38 500	139 500		
160			76 500	279 000	76 500	279 000	76 500	279 000		
200					126 000	458 000	126 000	458 000		
224					171 000	610 000	171 000	610 000		
250					224 000	797 000	224 000	797 000	224 000	797 000
315							353 000	1 221 000	353 000	1 221 000
355							464 000	1 617 000	-	-
400							552 000	1 924 000	552 000	1 924 000
500									1 672 000	4 672 000
630									2 381 000	6 837 000

# NH Fuse-Links AC 500 V gG

Fuse-Links

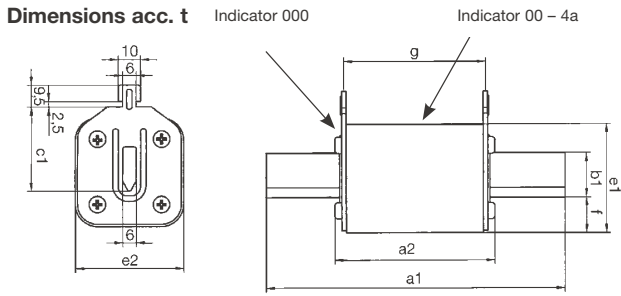

Size	Rated current	a <sub>1</sub>	a <sub>2</sub>	b <sub>1</sub>	c <sub>1</sub>	e <sub>1</sub>	e <sub>2</sub>	g
000		78,5	53	15	35	40	21	47
00	max. 160 A	78,5	53	15	35	47	30	47
1	max. 160 A	135	71	15	40	47	30	65
1	200 – 250 A	135	71	20	40	52	40	65
2	max. 250 A	150	72	20	48	52	40	65
2	300 – 400 A	150	72	26	48	60	51	65
3	max. 400 A	150	72	26	60	60	51	65
3	500 – 630 A	150	72	33	60	74	70	65
4a		200	96	50	85	109	98	86

**For cable and line protection**  
 Rated voltage: AC 500 V / DC see page 37  
 Utilization category: gG acc. to VDE 0636-2 and VDE 0636-1,  
 IEC 60269-1, IEC 60269-2  
 Application: For cable and line protection  
 Breaking capacity: 120 kA (AC 500 V) / DC see page 37

**Electrical characteristics:**  
 The time/current characteristics are matched to the cable and line capacities. Accordingly, the lines protected can be operated at optimal load as the breaking in case of overload is slow, but quick in the event of a short-circuit.  
 Even if devices of different brands are used that comply with the specifications, the definition of time-current ranges for category gG according to VDE 0636 and IEC 60269 ensures a selectivity of 1:1.6 at rated currents of ≥ 16 Amps.

Size	Amps	PU	Non-insulated metal gripping lugs Order no.	Insulated plastic gripping lugs Order no.	Insulated metal gripping lugs Order no.
000	2	3	35000-0020	35001-0020	
000	4	3	35000-0040	35001-0040	
000	6	3	35000-0060	35001-0060	
000	10	3	35000-0100	35001-0100	
000	16	3	35000-0160	35001-0160	
000	20	3	35000-0200	35001-0200	
000	25	3	35000-0250	35001-0250	
000	32	3	35000-0320	35001-0320	
000	35	3	35000-0350	35001-0350	
000	40	3	35000-0400	35001-0400	
000	50	3	35000-0500	35001-0500	
000	63	3	35000-0630	35001-0630	
000	80	3	35000-0800	35001-0800	
000	100	3	35000-1000	35001-1000	
00	2	3	35011-0010		35165-0010
00	4	3	35011-0020		35165-0020
00	6	3	35011-0030		35165-0030
00	10	3	35011-0040		35165-0040
00	16	3	35011-0050		35165-0050
00	20	3	35011-0060		35165-0060
00	25	3	35011-0070		35165-0070
00	32	3	35011-0080		35165-0080
00	35	3	35011-0090		35165-0090
00	40	3	35011-0100		35165-0100
00	50	3	35011-0110		35165-0110
00	63	3	35011-0120		35165-0120
00	80	3	35011-0130		35165-0130
00	100	3	35011-0140		35165-0140
00	125	3	35011-0150		35165-0150
00	160	3	35011-1090		35165-0160
1	25	3	35035-0050		35204-0050
1	32	3	35035-1220		35204-0160
1	35	3	35035-0060		35204-0060
1	40	3	35035-1230		35204-0170
1	50	3	35035-0070		35204-0070
1	63	3	35035-0080		35204-0080
1	80	3	35035-0090		35204-0090
1	100	3	35035-0100		35204-0110
1	125	3	35035-0110		35204-0110
1	160	3	35035-0120		35204-0120
1	200	3	35035-0130		35204-0130
1	224	3	35035-0140		35204-0140
1	250	3	35035-0150		35204-0150

# NH Fuse-Links AC 500 V gG

Size	Amps	PU	Non-insulated metal gripping lugs Order no.	Insulated metal gripping lugs Order no.
2	25	3	35054-0010	
2	35	3	35054-0020	
2	50	3	35054-0030	
2	63	3	35054-0040	35116-0040
2	80	3	35054-0050	35116-0050
2	100	3	35054-0060	35116-0060
2	125	3	35054-0070	35116-0070
2	160	3	35054-0080	35116-0080
2	200	3	35054-0090	35116-0090
2	224	3	35054-0100	35116-0100
2	250	3	35054-0110	35116-0110
2	(300)	3	35054-0120	35116-0120
2	315	3	35054-0130	35116-0130
2	(355)	3	35054-0140	35116-0140
2	400	3	35054-0150	35116-0150
3	63	3	35078-0340	35420-1000
3	80	3	35078-0350	35420-1250
3	100	3	35078-0360	35420-1600
3	125	3	35078-0370	35420-2000
3	160	3	35078-0380	35420-2240
3	200	3	35078-0390	35420-2500
3	224	3	35078-0400	35420-3000
3	250	3	35078-0410	35420-3150
3	(300)	3	35078-0190	35420-3550
3	315	3	35078-0010	35420-4000
3	(355)	3	35078-0020	35420-4250
3	400	3	35078-0030	35420-5000
3	(425)	3	35078-0040	35420-6300
3	500	3	35078-0050	
3	630	3	35078-0060	
4a	400	1	35097-0120	
4a	500	1	35097-0010	
4a	630	1	35097-0020	
4a	800	1	35097-0030	
4a	1000	1	35097-0040	
4a	1250	1	35097-0050	
4a	1600	1	35097-0110	

**Breaking capacity DC 500 V gG fuses:**

- Size 000: 40 kA, 250 V DC
- Size 00: 40 kA, 250V DC
- Size 1: 40 kA, 250 V DC
- Size 2: 40 kA, 250 V DC
- Size 3: 40 kA, 250 V DC
- Size 4a: 80 kA, 440 V DC

( ) = Dimensions according to DIN, rated current not standardized in VDE 0636

**NH Fuse-Links size 00 with striker**

In combination with a micro switch, EFEN NH fuse-links size 00 with striker can be used for fuse monitoring.

**Force-distance diagram of the striker**

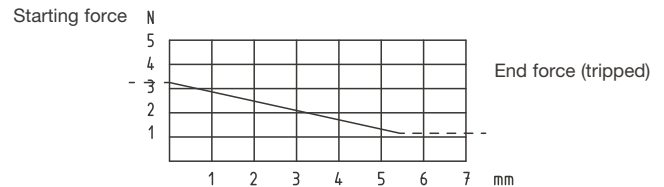

**NH Fuse-Links for cable and line protection size 00, 500 V AC, utilization category gL/gG, with striker**

Amps	Designation	Order no.
6	NH-Si 00 6A gL SM	35207-0010
10	NH-Si 00 10A gL SM	35207-0020
16	NH-Si 00 16A gL SM	35207-0030
20	NH-Si 00 20A gL SM	35207-0040
25	NH-Si 00 25A gL SM	35207-0050
32	NH-Si 00 32A gL SM	35207-0060
35	NH-Si 00 35A gL SM	35207-0070
40	NH-Si 00 40A gL SM	35207-0080
50	NH-Si 00 50A gL SM	35207-0090
63	NH-Si 00 63A gL SM	35207-0100
80	NH-Si 00 80A gL SM	35207-0110
100	NH-Si 00 100A gL SM	35207-0120
125	NH-Si 00 125A gL SM	35207-0130

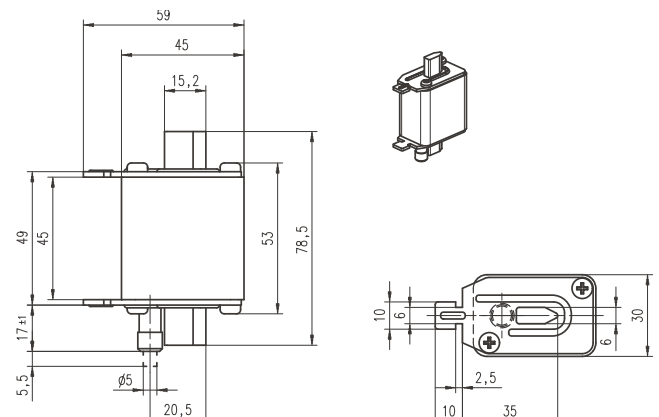

# NH Fuse-Links AC 500 V gG

Fuse-Links

For cable and line protection  
Time-current characteristics NH Fuse-Links size 000 acc. to VDE 0636-2 and IEC/EN 60269-2

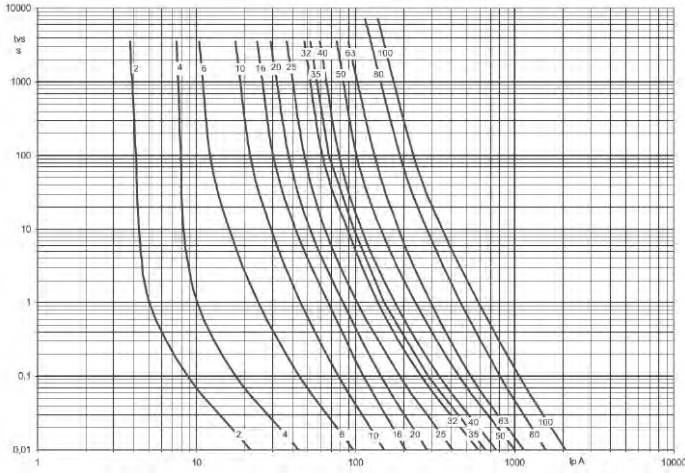

Time-current characteristics NH Fuse-Links size 00 – 4a gG 500 V AC acc. to VDE 0636-2 and IEC/EN 60269-2

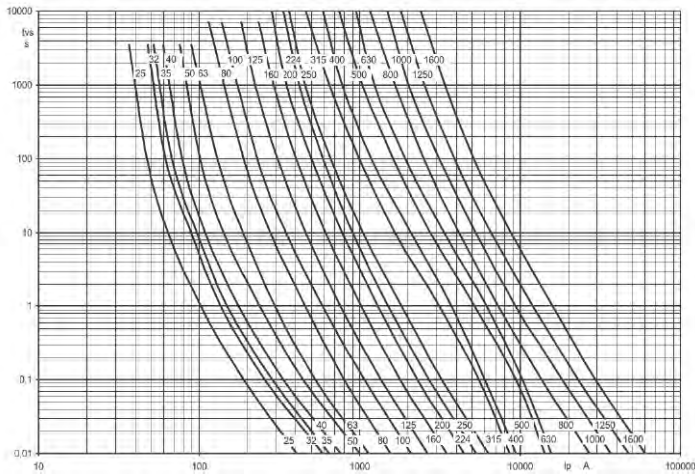

Cut-out current characteristics acc. to VDE 0636-2 and IEC/EN 60269-2

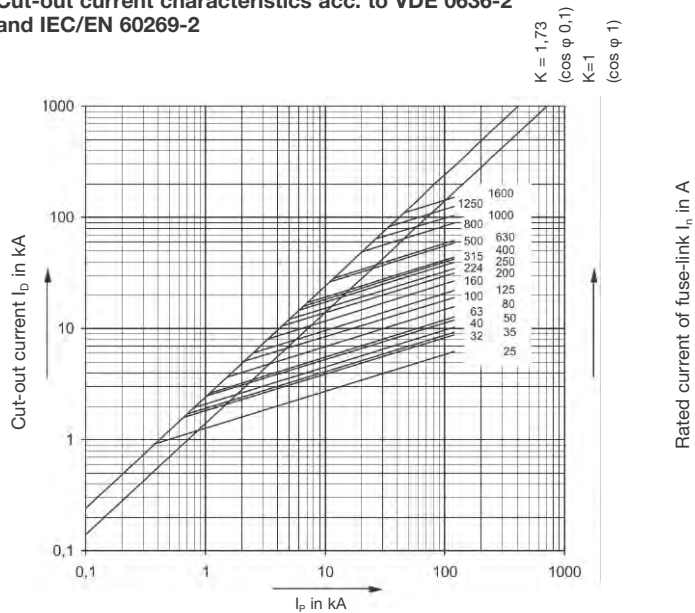

$I_p$  acc. to prospective short-circuit current  $I_k$  at point of fault (DIN/VDE 0102 part 2)

# NH Fuse-Links AC 500 V gG

Rated power dissipation  $P_w$  warm NH Fuse-Links size 000 – 4a gG AC 500 V acc. to VDE 0636-2 and IEC/EN 60269-2

$I_n$ A	Size					
	000	00	1	2	3	4a
6	1,6					
10	1,1					
16	1,8		1,8			
20	2,3		2,3			
25	2,4	2,4	2,4			
32	3,1	3,1	3,1			
35	3,0	3,0	3,0			
40	3,7	3,7	3,7			
50	4,1	4,1	4,1	4,1		
63	5,4	5,6	6,6	6,8		
80	6,5	6,8	8,0	8,3		
100	7,5	7,5	9,4	10,7		
125		10,0	11,8	12,2		
160		12,0	14,6	15,0		
200			18,0	18,5		
224			19,0	19,2	20,0	
250			20,0	20,6	21,1	
315				25,0	25,0	
355				31,5	32,0	
400				28,5	34,0	31,2
500					43,0	36,5
630					43,1	44,4
800						68,0
1000						72,9
1250						100,5
1600						126,2

Pre-arcing integrals and operating integrals in A<sup>2</sup>s of NH Fuse-Links size 000 – 4a, gG, AC 500 V, acc. to VDE 0636-2 and IEC/EN 60269-2

$I_n$ A	Size											
	000		00		1		2		3		4a	
	Pre-arcing	Operating	Pre-arcing	Operating	Pre-arcing	Operating	Pre-arcing	Operating	Pre-arcing	Operating	Pre-arcing	Operating
6	53,6	280										
10	109	490										
16	199	890										
20	430	1930										
25	890	4010	890	4010	990	4010	990	4010				
32	2475	6900	2475	6900	2475	6900	2475	6900				
35	2990	8380	2990	8380	2990	8380	2990	8380				
40	3970	10100	3970	10100	3970	10100	3970	10100				
50	6330	16150	6330	16150	6330	16150	6330	16150				
63	7430	20800	7430	20800	7430	20800	7430	20800	7430	20800		
80	14250	39900	14250	39900	14250	39900	14250	39900	14250	39900		
100	25340	70900	25340	70900	25340	71000	25340	71000	25340	71000		
125			39600	110800	39600	111000	39600	111000	39600	111000		
160			70400	197100	70400	197100	70400	197100	70400	197100		
200					114400	320000	114400	320000	114400	320000		
224					158400	444000	158400	444000	158400	444000		
250					228000	639000	228000	639000	228000	639000		
315							275900	773000	275900	773000		
355							356400	998000	356400	998000		
400							431200	1207000	431200	1207000	610500	927000
500									766600	2147000	1025 10 <sup>3</sup>	1618 10 <sup>3</sup>
630									912300	3013000	1767 10 <sup>3</sup>	2600 10 <sup>3</sup>
800											3499 10 <sup>3</sup>	5449 10 <sup>3</sup>
1000											5878 10 <sup>3</sup>	8708 10 <sup>3</sup>
1250											12164 10 <sup>3</sup>	18676 10 <sup>3</sup>
1600											20347 10 <sup>3</sup>	31278 10 <sup>3</sup>

# NH Fuse-Links 500 V AC gL

Fuse-Links

### For cable and line protection in meshed main systems

(ageing-resistant)  
 Rated voltage: AC 500 V  
 Utilization category: gL/gG acc. to VDE 0636-21 and IEC 60269-2  
 Application: For cable and line protection  
 Breaking capacity: 120 kA (size 00 – 2)

### Electrical characteristics

The time/current characteristics are matched to the cable and line capacities. Accordingly, the lines protected can be operated at optimal load as the breaking in case of overload is slow, but quick in the event of a short-circuit.

Even if devices of different brands are used that comply with the specifications, the definition of time-current ranges for category gL/gG acc. to VDE 0636 and IEC 60269-2 ensures a selectivity of 1:1.6. EFEN 500 V gL/gG fuse-links used in a 400 V grid have a selectivity of 1:1.25 for rated currents  $\geq 16$  A, i.e. between the increments of the rated currents.

EFEN PURE SILVER NH fuse-links 500 V gL/gG are specifically suited for use in meshed mains systems and show a selectivity factor of 0.79 when used in 400 V grids. Accordingly, if the maximum partial short-circuit current does not exceed 79% of the total short-circuit current, only the fuse-link closest to the failure point will be tripped. Thanks to the pure silver fuse element, this favourable factor is maintained throughout the component's entire service life.

Note: When used in meshed main systems, standard indicators do usually not respond reliably because of the low differential voltages. Please inquiry for a solution by EFEN.

### Dimensions: DIN 43620-1

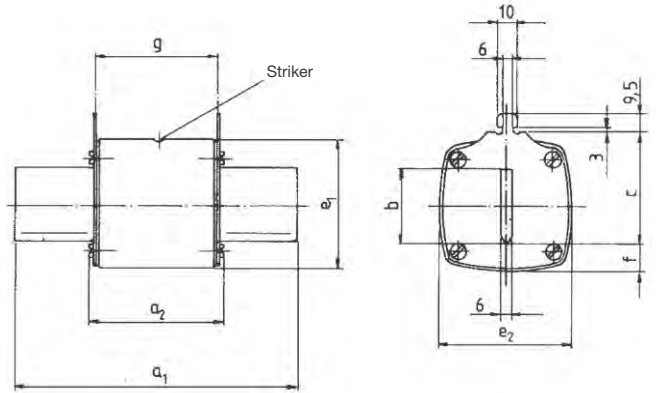

Size	a <sub>1</sub>	a <sub>2</sub>	b	c	e <sub>1</sub>	e <sub>2</sub>	f	g
00 <sup>1)</sup>	78,5	53	15	35	40	28	12,5	47
0	125	67	15	35	38	35	11,5	65
1 <sup>2)</sup>	135	74	20	40	38	35	9	65
1 <sup>3)</sup>	135	74	24,5	40	45	45	10	65
2 <sup>4)</sup>	150	74	25	48	45	45	10	65
2 <sup>5)</sup>	150	72	30	48	59	59	14,5	65
3 <sup>6)</sup>	150	72	40	60	70	70	15	65

- <sup>1)</sup> Rated current up to 160 A
- <sup>2)</sup> Rated current up to 125 A
- <sup>3)</sup> Rated current 160 – 250 A
- <sup>4)</sup> Rated current up to 250 A
- <sup>5)</sup> Rated current 300 – 400 A
- <sup>6)</sup> Rated current up to 630 A

### Rated power dissipation in Watts NH Fuse-Links Size 00 – 3 gL AC 500 V VDE 0636-2 and IEC/EN 60269-2

I <sub>n</sub> A	Size			
	00	1	2	3
2	0,25			
4	0,5			
6	1,0			
10	1,5			
16	1,9			
20	2,0			
25	2,2			
35	3,0			
50	3,75			
63	4,5			
80	4,8			
100	5,8			
125	8,8			
160	9,7			
200		15,7		
224		15,8		
250		16,4		
315			24,3	
355			26,2	
400			28,1	
500				33,0
630				42,0

### Breaking capacity DC 500 V gL

Size 00: 35 kA, 250V DC  
 Size 1: 35 kA, 440 V DC  
 Size 2: 35 kA, 440 V DC

# NH Fuse-Links 500 V AC gL

Time-current characteristics acc. to VDE 0636-2 and IEC/EN 60269-2

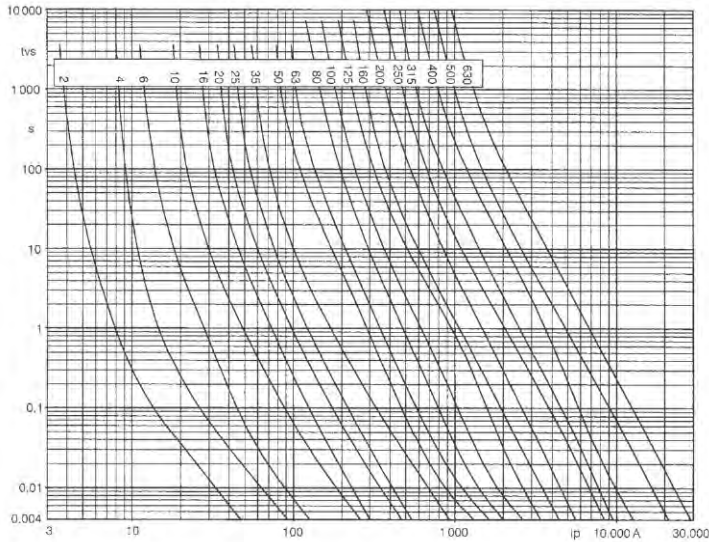

Cut-out current characteristics acc. to VDE 0636-2 and IEC/EN 60269-2

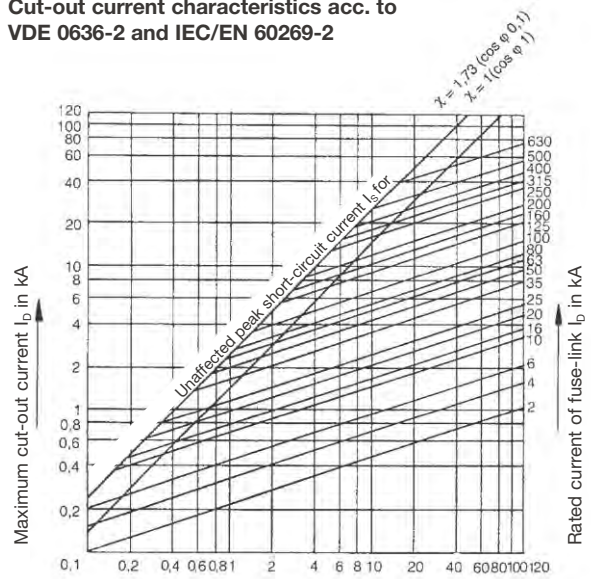

$I_p$  acc. to prospective short-circuit current  $I_k$  at point of fault (DIN/VDE 0102 part 2)

Rated power dissipation acc. to VDE 0636-2 and IEC/EN 60269-2

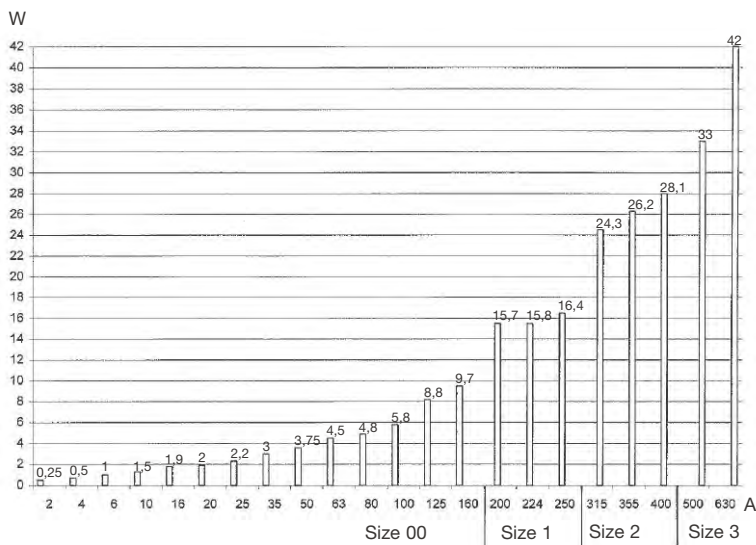

Pre-arcing and operating integrals acc. to VDE 0636-2 and IEC/EN 60269-2

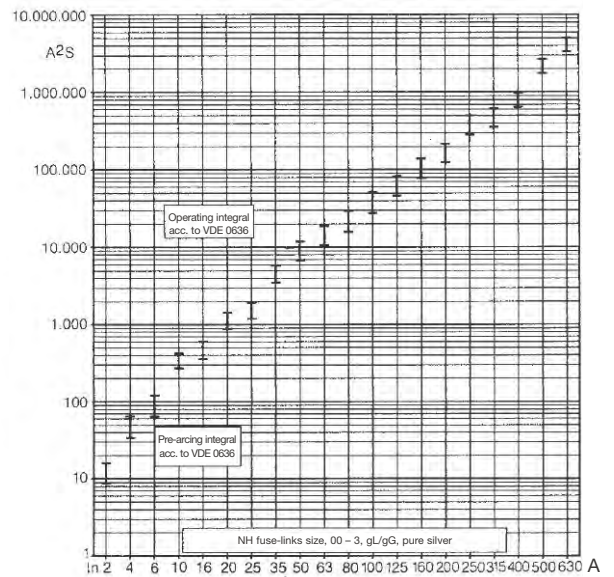

# NH Fuse-Links AC 690 V gG

Fuse-Links

**For cable and line protection**

Rated voltage: AC 690 V  
 Utilization category: gG acc. to VDE 0636-2 and VDE 0636-1, IEC 60269-2, IEC 60269-1  
 Application: For cable and line protection  
 Breaking capacity: 100 kA (630 A, 50 kA)

Size	Amps	PU	Metal gripping lugs Order no.
000	2	3	35421-0020
000	4	3	35421-0040
000	6	3	35421-0060
000	10	3	35421-0100
000	16	3	35421-0160
000	20	3	35421-0200
000	25	3	35421-0250
000	32	3	35421-0320
000	35	3	35421-0350
000	40	3	35421-0400
000	50	3	35421-0500
000	63	3	35421-0630
000	80	3	35422-0800
000	100	3	35422-1000
000	125	3	35422-1250
1	25	3	35423-0250
1	32	3	35423-0320
1	35	3	35423-0350
1	40	3	35423-0400
1	50	3	35423-0500
1	63	3	35423-0630
1	80	3	35423-0800
1	100	3	35423-1000
1	125	3	35423-1250
1	160	3	35423-1600
1	200	3	35423-2000
1	250	3	35423-2500
2	25	3	35424-0250
2	35	3	35424-0350
2	50	3	35424-0500
2	63	3	35424-0630
2	80	3	35424-0800
2	100	3	35424-1000
2	125	3	35424-1250
2	160	3	35424-1600
2	200	3	35424-2000
2	250	3	35424-2500
2	315	3	35424-3150
2	355	3	35424-3550
2	400	3	35424-4000
3	80	3	35425-0800
3	100	3	35425-1000
3	125	3	35425-1250
3	160	3	35425-1600
3	200	3	35425-2000
3	224	3	35425-2240
3	250	3	35425-2500
3	315	3	35425-3150
3	355	3	35425-3550
3	400	3	35425-4000
3	425	3	35425-4250
3	500	3	35425-5000
3	630	3	35425-6300

**Electrical characteristics:**

The time/current characteristics are matched to the cable and line capacities. Accordingly, the lines protected can be operated at optimal load as the breaking in case of overload is slow, but quick in the event of a short-circuit.

**Dimensions: DIN 43620-1**

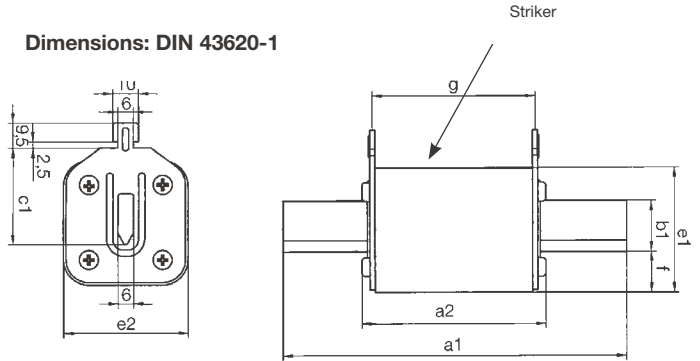

Size	Rated current	a <sub>1</sub>	a <sub>2</sub>	b <sub>1</sub>	c <sub>1</sub>	e <sub>1</sub>	e <sub>2</sub>	g
000	6-63 A	78,5	53	15	35	37	21	47
00	80-100 A	78,5	53	15	35	45	30	47
1	25-160 A	135	70	15	40	45	30	65
1	200-250 A	135	70	20	40	50	50	65
2	25-250 A	150	71	20	48	50	50	65
2	315-400 A	150	71	26	48	58	58	65
3	63-400 A	150	71	26	60	58	58	65
3	500 A, 630 A	150	74	32	60	71	71	65

**Rated power dissipation P<sub>a</sub> in Watts NH Fuse-Links size 000 – 3 gG AC 690 V VDE 0636-2 IEC 60269-2**

I <sub>n</sub> A	Size				
	000	00	1	2	3
2	1,9				
4	1,5				
6	1,6				
10	1,7				
16	2,5				
20	2,6				
25	2,8		3,6		
32	3,1		3,7		
35	3,2		3,9	3,7	
40	3,7		4,4	4,4	
50	4,1		4,8	5,4	
63	5,4		6,6	6,8	
80		6,8	8,0	8,3	
100		7,5	9,4	10,7	
125		10,0	11,8	12,2	
160			14,6	15,5	
200			19,0	19,0	
224			-	-	
250			22,0	22,0	21,1
315				27,0	25,0
355				32,0	32,0
400					34,0
500					43,0
630					52,0

( ) = Dimensions according to DIN, rated current not standardized in VDE 0636

# NH Fuse-Links AC 690 V gG

For cable and line protection

Time-current characteristics acc. to VDE 0636-2 and IEC/EN 60269-2

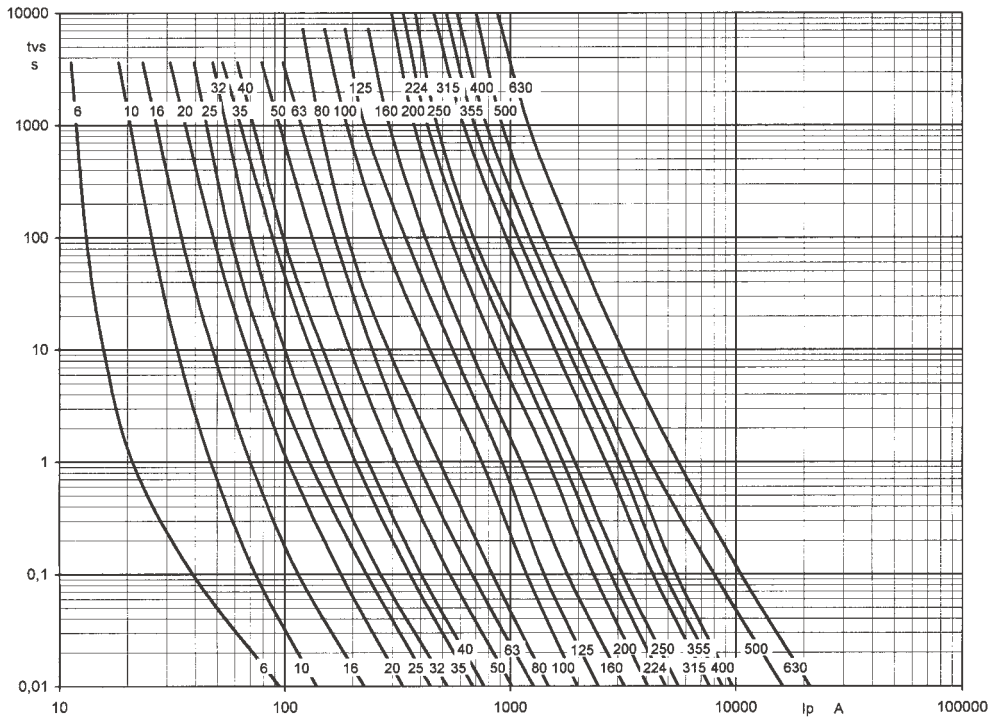

Cut-out current characteristics acc. to VDE 0636-2 and IEC/EN 60269-2

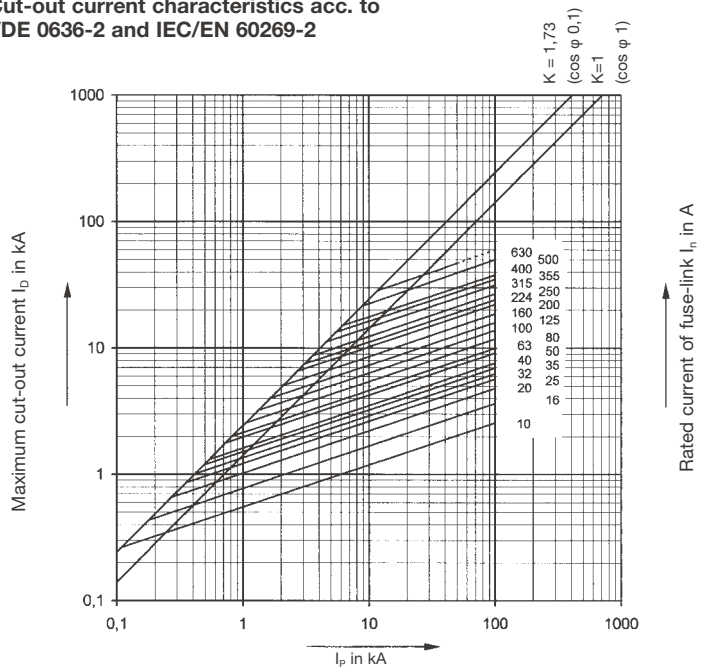

$I_p$  acc. to prospective short-circuit current  $I_k$  at point of fault (DIN/VDE 0102 part 2)

Breaking capacity of DC 690 V gG fuses:

- Size 000: 40 kA, 250 V DC
- Size 00: 40 kA, 250 V DC
- Size 1: 80 kA, 440 V DC
- Size 2: 40 kA, 250 V DC
- 80 kA, 440 V DC
- Size 3: 40 kA, 250 V DC
- 80 kA, 400 V DC

# NH Fuse-Links AC 400 V gTr

Fuse-Links

**For transformer protection**

Rated voltage: AC 400 V  
 Utilization category: gTr acc. to VDE 0636-2011  
 Application: For transformer protection  
 Breaking capacity: 100 kA

Size	Amps	kVA	PU	Metal gripping lugs Order no.
2	(72)	50	3	35076-1010
2	(108)	75	3	35076-1020
2	(144)	100	3	35076-1030
2	(180)	125	3	35076-1040
2	(231)	160	3	35076-1050
2	(289)	200	3	35076-1060
2	(361)	250	3	35076-1070
3	(144)	100	3	35081-1040
3	(231)	160	3	35081-1060
3	(289)	200	3	35081-1050
3	(361)	250	3	35081-1010
3	(455)	315	3	35081-1020
3	(577)	400	3	35081-1030
3	(722)	500	3	35081-0100
3	(909)	630	3	35081-0110
4a	(144)	100	1	35100-0100
4a	(231)	160	1	35100-0110
4a	(289)	200	1	35100-0160
4a	(361)	250	1	35100-0120
4a	(455)	315	1	35100-0170
4a	(577)	400	1	35100-0130
4a	(722)	500	1	35100-0140
4a	(909)	630	1	35100-0150
4a	(1155)	800	1	35100-0040
4a	(1443)	1000	1	35100-0190

( ) = Dimensions according to DIN, rated current not standardized in VDE 0636

**Electrical characteristics:**

Time-current characteristics are matched to the thermal capacity of the transformers and the time-current characteristics of the high-voltage fuse-links. The gTr fuse-link supplements the high-voltage fuse-link in the "non-permissible" overcurrent range. This allows a better utilization of the transformers' overload capacities. EFEN transformer fuse-links are able to carry the 1.3-fold of the transformer rated current for a minimum period of 10 hours. The fuse-link trips at the 1.5-fold transformer rated current within a period of 2 hours. Transformer fuse-links are designated in accordance with the transformer rated current in kVA.

**Dimensions: DIN 43620-1**

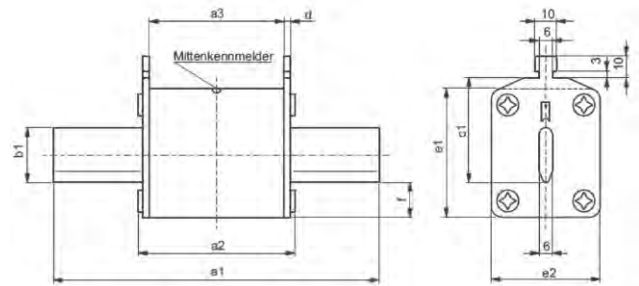

**NH Fuse-Links AC 400 V gTr with non-insulated gripping lugs**

Size	Rated current	a1	a2	a3	d	b1	c1	e1	e2	f
2/	50 – 160 kVA	150	72	62	2,5	20	48	48	40	12
2	200 – 250 kVA	150	72	62	2,5	25	48	59	50	14
3/	100 – 250 kVA	150	73	62	2,8	25	60	59	50	13
3	315 – 630 kVA	150	73	62	2,8	32	60	71	71	17
4a/	100 – 400 kVA	200	96	84	3	32	85	71	73	18
4	500 – 1000 kVA	200	96	84	4	50	85	109	98	27

**Rated power dissipation P<sub>a</sub> in Watts of NH Fuse-Links size 2 – 4a gTr AC 400 V VDE 0636 part 2011**

Transformer rated output	Rated current	Size		
		2	3	4a
50	72	5,5	5,5	
75	102	7,8	7,8	
100	144	10,6	10,1	12,0
125	180	12,8	12,8	15,0
160	231	15,7	16,2	14,8
200	289	16,0	16,0	22,5
250	361	21,0	20,6	28,0
315	455	25,0	25,0	31,5
400	577		31,0	39,0
500	722		53,0	49,0
630	909		62,0	66,0
800	1155			81,0
1000	1443			110,0

# NH Fuse-Links AC 400 V gTr

For transformer protection

Time-current characteristics acc. to VDE 0636-2 and IEC/EN 60269-2

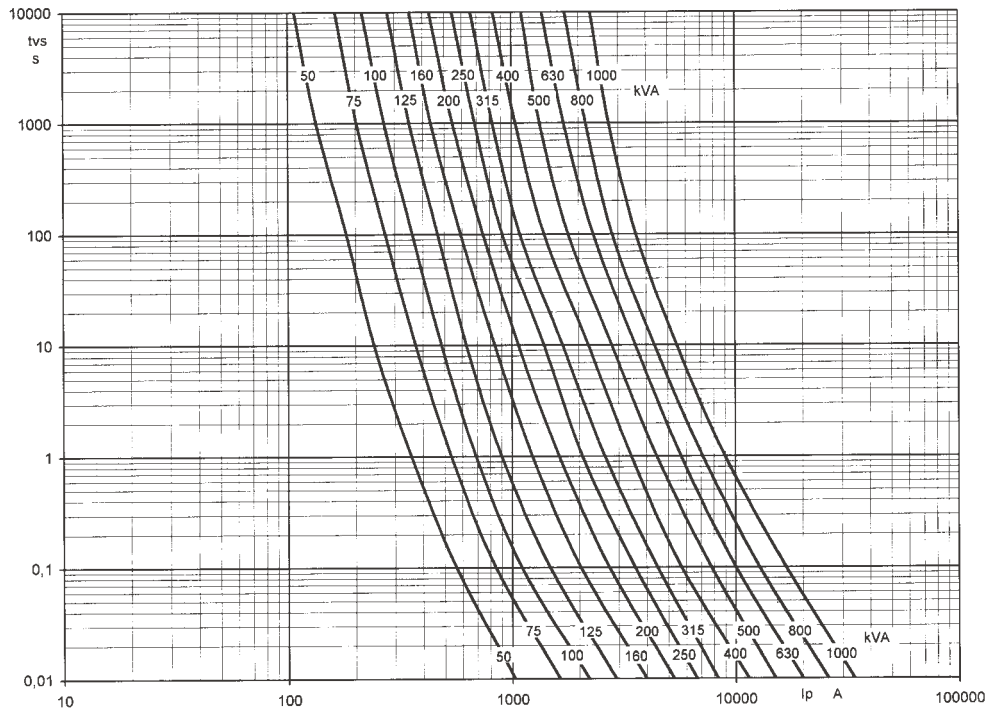

Cut-out current characteristics acc. to VDE 0636-2 and IEC/EN 60269-2

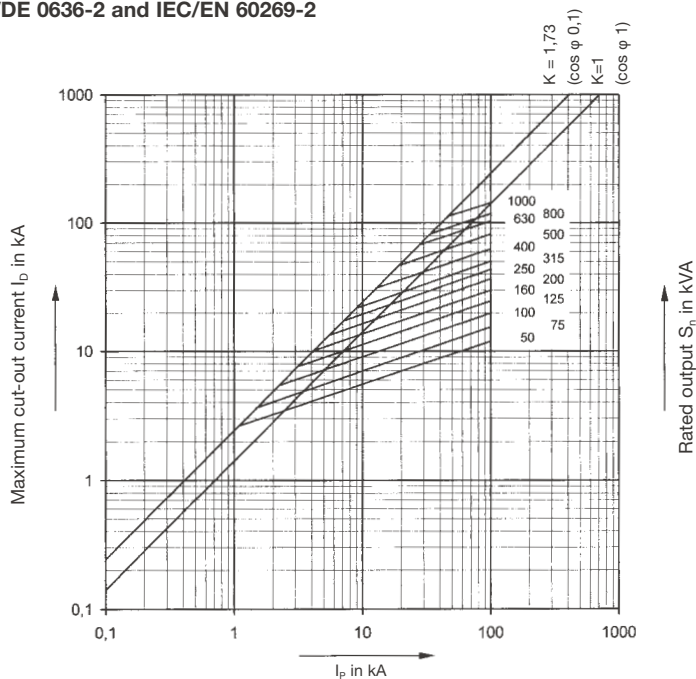

$I_p$  acc. to prospective short-circuit current  $I_k$  at point of fault (DIN/VDE 0102 part 2)

# NH Fuse-Links AC 500 V gR

**For semiconductor protection – pure silver fuse element**  
 Rated voltage: AC 500 V  
 Utilization category: gR acc. to VDE 0636-4  
 Application: For semiconductor protection  
 Breaking capacity: 120 kA

**Without striker**

Size	Amps	PU	Metal gripping lugs Order no.
00	16	3	35024-0180
00	20	3	35024-0170
00	25	3	35024-0190
00	35	3	35024-0010
00	40	3	35024-0020
00	50	3	35024-0030
00	63	3	35024-0040
00	80	3	35024-0050
00	100	3	35024-0060
00	125	3	35024-0070
00	160	3	35024-0080
1	35	3	35040-0010
1	50	3	35040-0020
1	63	3	35040-0030
1	80	3	35040-0040
1	100	3	35040-0050
1	125	3	35040-0060
1	160	3	35040-0070
1	200	3	35040-0080
1	(224)	3	35040-0090
1	250	3	35040-0100
2	80	3	35058-0010
2	100	3	35058-0020
2	125	3	35058-0030
2	160	3	35058-0040
2	200	3	35058-0050
2	(224)	3	35058-0060
2	250	3	35058-0070
2	(300)	3	35058-0080
2	315	3	35058-0090
2	(355)	3	35058-0100
2	400	3	35058-0110
3	315	1	35079-0010
3	(355)	1	35079-0020
3	400	1	35079-0030
3	(425)	1	35079-0040
3	500	1	35079-0050
3	630	1	35079-0060

( ) = Dimensions according to DIN,  
 rated current not standardized in VDE 0636

**Dimensions: DIN 43620-1**

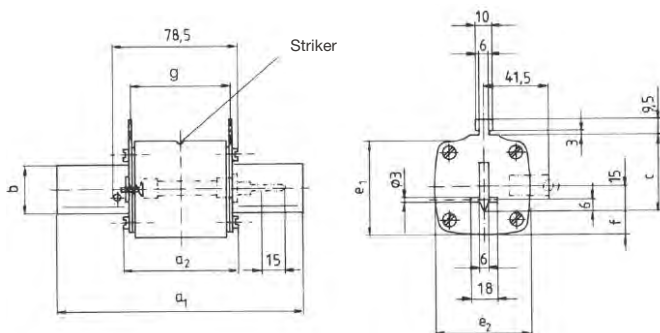

**Electrical characteristics:**

EFEN NH fuse-links for semiconductor protection feature the following properties:

1. ultra-quick time-current characteristics adjusted to protection requirements
  2. a low arc voltage characteristic with low overvoltage
- EFEN gR fuse-links may be used as full-range fuses for overload and short-circuit protection or in conjunction with other overcurrent protection devices to provide short-circuit protection only.

**Variant with striker:**

A spring-loaded striker pin is provided in parallel with the fuse-link. When the NH fuse-link trips, the striker pin is released, actuating the micro-switch on the NH fuse-base.

**With striker**

Size	Amps	PU	Metal gripping lugs Order no.
00	16	3	35218-0010
00	20	3	35218-0020
00	25	3	35218-0030
00	35	3	35218-0040
00	40	3	35218-0050
00	50	3	35218-0060
00	63	3	35218-0070
00	80	3	35218-0080
00	100	3	35218-0090
00	125	3	35218-0100
1	35	1	35046-0010
1	50	1	35046-0020
1	63	1	35046-0030
1	80	1	35046-0040
1	100	1	35046-0050
1	125	1	35046-0060
1	160	1	35046-0070
1	200	1	35046-0080
1	(224)	1	35046-0090
1	250	1	35046-0100
2	80	1	35060-0050
2	100	1	35060-0060
2	125	1	35060-0070
2	160	1	35060-0080
2	200	1	35060-0090
2	(224)	1	35060-0100
2	250	1	35060-0110
2	(300)	1	35060-0120
2	(315)	1	35060-0130
2	355	1	35060-0140
2	400	1	35060-0150
3	315	1	35086-0010
3	(355)	1	35086-0020
3	400	1	35086-0030
3	(425)	1	35086-0040
3	500	1	35086-0050
3	630	1	35086-0060

Size	a <sub>1</sub>	a <sub>2</sub>	b	c	e <sub>1</sub>	e <sub>2</sub>	f	g
00	78,5	53	15	35	40	28	12,5	47
0	125	67	15	35	38	35	11,5	65
1	135	71	24,5	40	45	45	10	65
2	150	72	30	48	59	59	14,5	65
3	150	72	40	60	70	70	15	65

## NH Fuse-Links AC 500 V gR

Rated power dissipation in Watts of NH Fuse-Links size 00 – 3  
gR AC 500 V VDE 0636-4

I <sub>n</sub> A	Size			
	00	01	2	3
16	6,0			
20	7,2			
25	8,0			
35	9,6	12,6		
50	12,0	14,0		
63	14,0	17,2		
80	17,7	21,2	20,0	
100	25,7	27,5	27,1	
125	29,7	31,2	29,7	
160	45,3	38,0	35,5	
200		46,0	43,9	
224		56,9	51,9	
250		65,0	56,8	
300			<b>67,7</b>	
315			68,7	67,7
355			80,6	77,5
400			91,6	88,5
425				97,2
500				115,7
630				168,3

Breaking capacity DC 500 V gR

Size 00: 25 kA, 240 V DC  
 Size 1: 25 kA, 440 V DC  
 Size 2: 25 kA, 440 V DC  
 Size 3: 25 kA, 440 V DC

# NH Fuse-Links AC 500 V gR

Fuse-Links

For semiconductor protection – pure silver fuse element

Time-current characteristics acc. to VDE 0636-2 and IEC/EN 60269-2

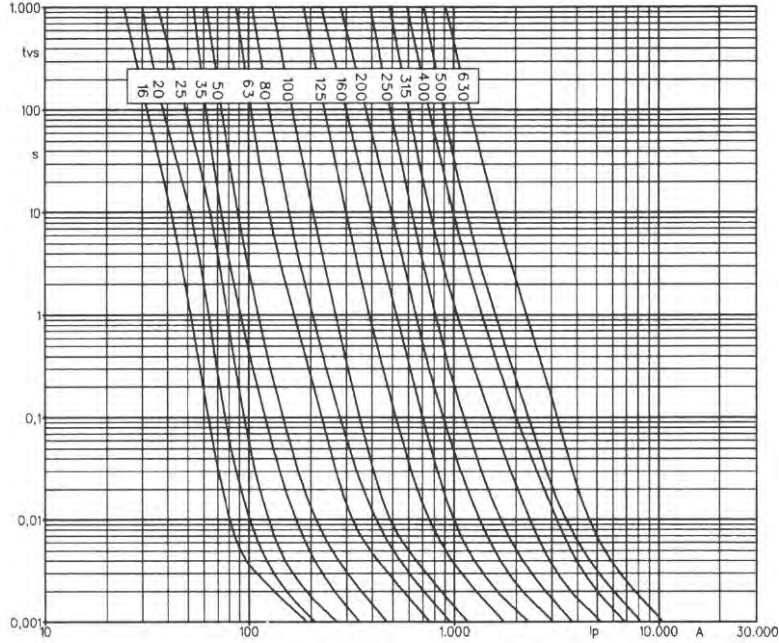

Force-distance diagram of the striker

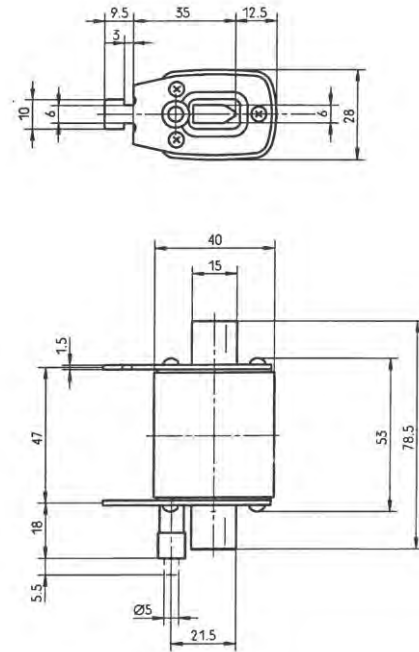
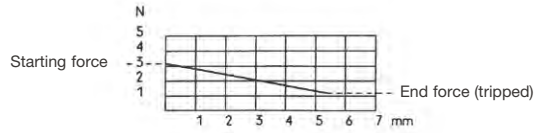

Cut-out current characteristics acc. to VDE 0636-2 and IEC/EN 60269-2

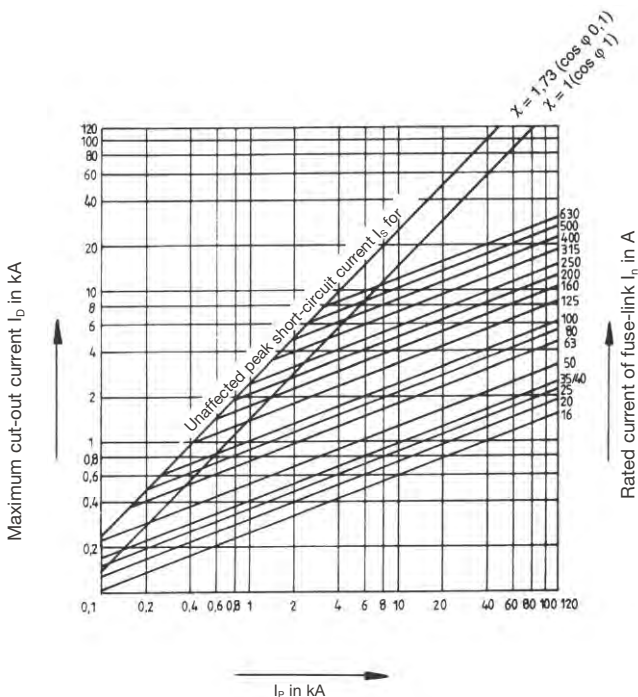

Pre-arcing and operating integrals acc. to VDE 0636-2 and IEC/EN 60269-2

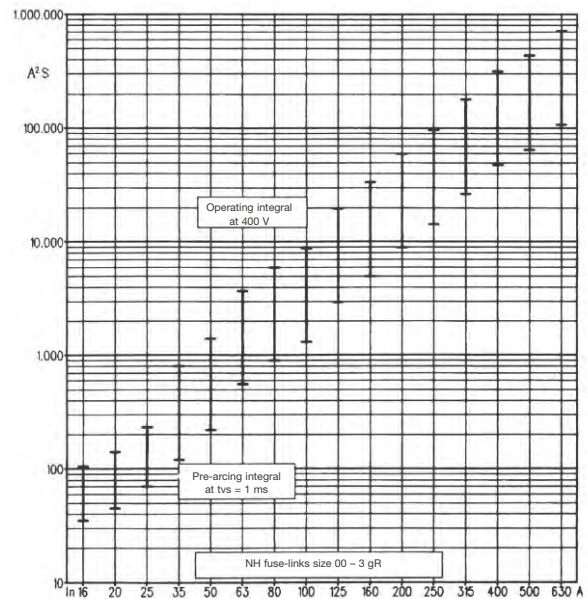

$I_p$  acc. to prospective short-circuit current  $I_k$  at point of fault (DIN / VDE 0102 part 2)

## NH Fuse-Links 1000 V / 1500 V

### For mining equipment protection – pure silver fuse element (ageing-resistant)

Rated voltage: AC 1000 V

Utilization category: gB and aM acc. to VDE 0636-2011

Application: gB – full-range protection of mining equipment

aM – back-up protection for mining equipment

Breaking capacity: 25 kA

#### Electrical characteristics:

- NH fuse-links of utilization category gB
- NH fuse-links of utilization category aM provide back-up protection for switchgear devices. They protect switchgear devices in the event of short-circuits. When combined with overcurrent protection devices, they provide optimal protection to downstream motors and devices. The PURE SILVER fuse elements ensure that the NH fuse-links resist ageing while retaining their selectivity.

EFEN NH fuse-links of utilization categories aM respond quickly in case of short-circuits but are not tripped by overcurrent as this function is performed by other overcurrent protection devices.

Size	a <sub>1</sub>	a <sub>2</sub>	b	c	e <sub>1</sub>	e <sub>2</sub>	f	g
1L	170	105,5	24,5	40	45	45	10	105,5
3	167,5	92,5	32	60	72	72	15	80,5

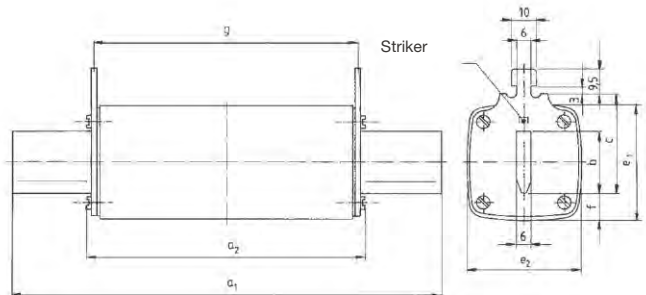

### Special-purpose designs and characteristics

Rated voltage: 1000 and 1500 V AC

Utilization category: TF acc. to DIN 43 620-5

Application: Protection of rectifier equipment for electric railway systems

Breaking capacity: 10 kA

#### Electrical characteristics:

These special-purpose fuse-links have been designed for use in rectifier stations in railway systems. They feature dual time-current characteristics and PURE SILVER fuse elements. This makes these fuse-links especially resistant to ageing.

The fuse-links withstand overcurrents and inrush currents, but quickly interrupt short-circuits. Due to the quick response characteristic, short-circuit currents are cut out at low current levels.

#### Variant with striker:

A spring-loaded striker pin is provided in parallel with the fuse-link. When the NH fuse-link trips, the striker pin is released, actuating the micro-switch on the NH fuse-base.

Size	a <sub>1</sub>	a <sub>2</sub>	b	c	e <sub>1</sub>	e <sub>2</sub>	f	g
3L	206	130	40	60	67	67	13,5	120

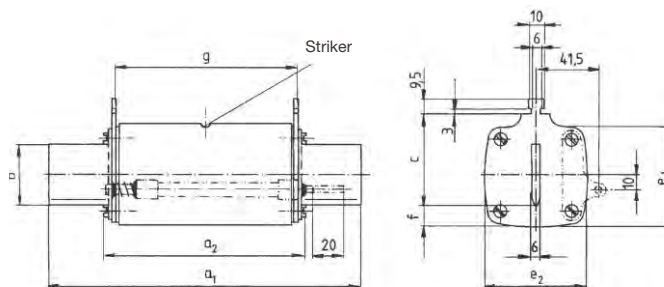

## NH maintenance fuse-link

### Application:

NH maintenance fuse-links are used to temporarily replace line-protection fuse-links (gG) in power grids during maintenance work. The feature ultra-quick time-current characteristics. Accordingly, maximum cut-out current and maximum cut-out energy are limited even more strictly than in NH fuse-links of utilization category gG. This means less risk by potential current arcing to the maintenance personnel.

NH maintenance fuse-links are not optimally suited for normal operation as they trip more quickly in the case of temporary overload. Also, their power dissipation is much higher than that of fuse-links of category gG. For normal operation we recommend our ageing-resistant NH fuse-links of utilization category gG.

- Less cut-out energy and lower cut-out currents thanks to ultra-quick time-current characteristics means more safety for the maintenance personnel
- Insulated metal gripping lugs protect against accidental contact with live parts
- Ageing-resistant pure silver fuse element
- Locked screws that do not come lose
- Reliable function even after years inside a service vehicle
- Clear identification in red color as "maintenance fuse-link"

Size	Amps	Designation	Order no.
2	80	NH-Arbeitssicherung 80A gR Li	<b>35209-0010</b>
2	100	NH-Arbeitssicherung 100A gR Li	<b>35209-0020</b>
2	125	NH-Arbeitssicherung 125A gR Li	<b>35209-0030</b>
2	160	NH-Arbeitssicherung 160A gR Li	<b>35209-0040</b>
2	200	NH-Arbeitssicherung 200A gR Li	<b>35209-0050</b>
2	224	NH-Arbeitssicherung 224A gR Li	<b>35209-0060</b>
2	250	NH-Arbeitssicherung 250A gR Li	<b>35209-0070</b>
2	300	NH-Arbeitssicherung 300A gR Li	<b>35209-0080</b>
2	315	NH-Arbeitssicherung 315A gR Li	<b>35209-0090</b>

## NH maintenance fuse-link

Maintenance fuse-link and gG fuse-link compared

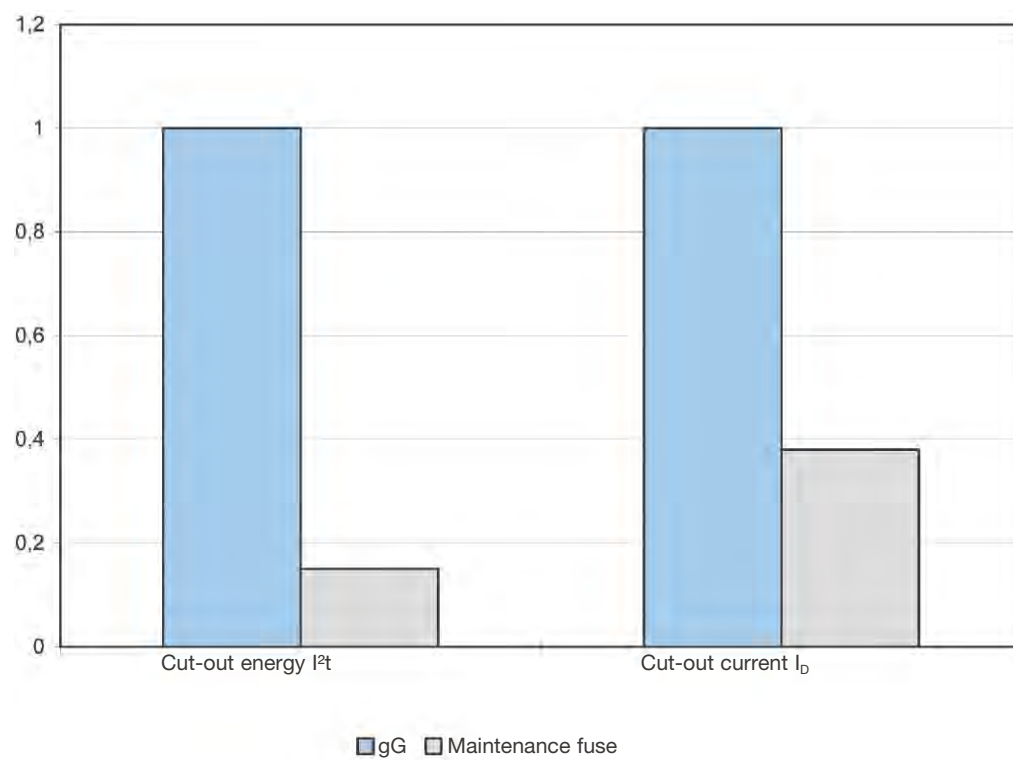

## NH Fuse-Links for DC applications up to 80 V - series TPS

► Technical data, page 55



35300-0600

### TPS fault terminator Fuse-Links

**Features:**

- Compact design
- Use only with TPS fuse isolators (page 133)

Designation	Size	Amps	PU	Product designation	Order no.
TPS FAULT TERMINATOR 60 A	00	60	3	U TPS FAULT TERMINATOR 60A	<b>35300-0060</b>
TPS FAULT TERMINATOR 80 A	00	80	3	U TPS FAULT TERMINATOR 80A	<b>35300-0080</b>
TPS FAULT TERMINATOR 100 A	00	100	3	U TPS FAULT TERMINATOR 100A	<b>35300-0100</b>
TPS FAULT TERMINATOR 150 A	00	150	3	U TPS FAULT TERMINATOR 150A	<b>35300-0150</b>
TPS FAULT TERMINATOR 200 A	00	200	3	U TPS FAULT TERMINATOR 200A	<b>35300-0200</b>
TPS FAULT TERMINATOR 250 A	00	250	3	U TPS FAULT TERMINATOR 250A	<b>35300-0250</b>
TPS FAULT TERMINATOR 300 A	00	300	3	U TPS FAULT TERMINATOR 300A	<b>35300-0300</b>
TPS FAULT TERMINATOR 400 A	00	400	3	U TPS FAULT TERMINATOR 400A	<b>35300-0400</b>
TPS FAULT TERMINATOR 500 A	00	500	3	U TPS FAULT TERMINATOR 500A	<b>35300-0500</b>
TPS FAULT TERMINATOR 600 A	00	600	3	U TPS FAULT TERMINATOR 600A	<b>35300-0600</b>
TPS FAULT TERMINATOR 800 A	2	800	1	U TPS FAULT TERMINATOR 800A	<b>35330-0800</b>
TPS FAULT TERMINATOR 1000 A	2	1000	1	U TPS FAULT TERMINATOR 1000A	<b>35330-1000</b>
TPS FAULT TERMINATOR 1200 A	2	1200	1	U TPS FAULT TERMINATOR 1200A	<b>35330-1200</b>
TPS FAULT TERMINATOR 1600 A	2	1600	1	U TPS FAULT TERMINATOR 1600A	<b>35330-1600</b>



35301-0100

### TPS Fault Terminator with striker for fuse-monitoring

**Features:**

- Compact design
- Use only with TPS fuse isolators (page 133)

Designation	Size	Amps	PU	Product designation	Order no.
TPS FAULT TERMINATOR 60 A SM	00	60	3	U TPS FAULT TERMINATOR 60A SM	<b>35301-0060</b>
TPS FAULT TERMINATOR 80 A SM	00	80	3	U TPS FAULT TERMINATOR 80A SM	<b>35301-0080</b>
TPS FAULT TERMINATOR 100 A SM	00	100	3	U TPS FAULT TERMINATOR 100A SM	<b>35301-0100</b>
TPS FAULT TERMINATOR 150 A SM	00	150	3	U TPS FAULT TERMINATOR 150A SM	<b>35301-0150</b>
TPS FAULT TERMINATOR 200 A SM	00	200	3	U TPS FAULT TERMINATOR 200A SM	<b>35301-0200</b>
TPS FAULT TERMINATOR 250 A SM	00	250	3	U TPS FAULT TERMINATOR 250A SM	<b>35301-0250</b>
TPS FAULT TERMINATOR 300 A SM	00	300	3	U TPS FAULT TERMINATOR 300A SM	<b>35301-0300</b>
TPS FAULT TERMINATOR 400 A SM	00	400	3	U TPS FAULT TERMINATOR 400A SM	<b>35301-0400</b>
TPS FAULT TERMINATOR 500 A SM	00	500	3	U TPS FAULT TERMINATOR 500A SM	<b>35301-0500</b>
TPS FAULT TERMINATOR 600 A SM	00	600	3	U TPS FAULT TERMINATOR 600A SM	<b>35301-0600</b>

# NH Fuse-Links for DC applications up to 550 V

► Technical data, page 55



35178-0020

## NH battery fuse DC 550 V

### Features:

- Clear identification for protection against mix-up
- Selection guide 56

Designation	Size	Amps	PU	Product designation	Order no.
NH-BATTERIESICHERUNG 00 E	00		3	NH-BATTERIESICHERUNG 00 E	<b>35177-0010</b>
NH-BATTERIESICHERUNG 00 G	00		3	NH-BATTERIESICHERUNG 00 G	<b>35177-0030</b>
NH-BATTERIESICHERUNG 00 H	00		3	NH-BATTERIESICHERUNG 00 H	<b>35177-0040</b>
NH-BATTERIESICHERUNG 00 A	00		3	NH-BATTERIESICHERUNG 00 A	<b>35177-0050</b>
NH-BATTERIESICHERUNG 00 B	00		3	NH-BATTERIESICHERUNG 00 B	<b>35177-0060</b>
NH-BATTERIESICHERUNG 00 C	00		3	NH-BATTERIESICHERUNG 00 C	<b>35177-0070</b>
NH-BATTERIESICHERUNG 00 D	00		3	NH-BATTERIESICHERUNG 00 D	<b>35177-0080</b>
NH-BATTERIESICHERUNG 1 A	2C		3	NH-BATTERIESICHERUNG 1 A	<b>35178-0010</b>
NH-BATTERIESICHERUNG 1 B	2C		3	NH-BATTERIESICHERUNG 1 B	<b>35178-0020</b>
NH-BATTERIESICHERUNG 1 C	2C		3	NH-BATTERIESICHERUNG 1 C	<b>35178-0030</b>
NH-BATTERIESICHERUNG 2 A	2		3	NH-BATTERIESICHERUNG 2 A	<b>35179-0010</b>
NH-BATTERIESICHERUNG 2 B	2		3	NH-BATTERIESICHERUNG 2 B	<b>35179-0020</b>
NH-BATTERIESICHERUNG 3 A	3		1	NH-BATTERIESICHERUNG 3 A	<b>35180-0010</b>
NH-BATTERIESICHERUNG 3 B	3		1	NH-BATTERIESICHERUNG 3 B	<b>35180-0020</b>
NH-BATTERIESICHERUNG 3 C	3		1	NH-BATTERIESICHERUNG 3 C	<b>35180-0030</b>
NH-BATTERIESICHERUNG 4 C	4a		1	NH-BATTERIESICHERUNG 4 C	<b>35183-0020</b>
NH-BATTERIESICHERUNG 4 D	4a		1	NH-BATTERIESICHERUNG 4 D	<b>35183-0030</b>
NH-BATTERIESICHERUNG 4 E	4a		1	NH-BATTERIESICHERUNG 4 E	<b>35183-0040</b>

## NH Fuse-Links 1000 V DC

► Technical data, page 49



35089-0190

### NH Fuse-Links, size 3L, special design

#### Features:

- AC 1000 V (425 – 500 A), AC 1500 V (6 – 355 A), 25 kA DC 1000 V 6 – 355 A
- Breaking capacity: 10 kA
- TF acc. to VDE 0660 and DIN 43620-5

Designation	Size	Amps	PU	Product designation	Order no.
NH-SI 3L 6A TF AC1500V LS	3L	6	3	NH-SI 3L 6A TF AC1500V LS	<b>35089-0200</b>
NH-SI 3L 10A TF AC1500V LS	3L	10	3	NH-SI 3L 10A TF AC1500V LS	<b>35089-0010</b>
NH-SI 3L 16A TF AC1500V LS	3L	16	3	NH-SI 3L 16A TF AC1500V LS	<b>35089-0020</b>
NH-SI 3L 20A TF AC1500V LS	3L	20	3	NH-SI 3L 20A TF AC1500V LS	<b>35089-0030</b>
NH-SI 3L 25A TF AC1500V LS	3L	25	3	NH-SI 3L 25A TF AC1500V LS	<b>35089-0040</b>
NH-SI 3L 35A TF AC1500V LS	3L	35	3	NH-SI 3L 35A TF AC1500V LS	<b>35089-0050</b>
NH-SI 3L 50A TF AC1500V LS	3L	50	3	NH-SI 3L 50A TF AC1500V LS	<b>35089-0060</b>
NH-SI 3L 63A TF AC1500V LS	3L	63	3	NH-SI 3L 63A TF AC1500V LS	<b>35089-0070</b>
NH-SI 3L 80A TF AC1500V LS	3L	80	3	NH-SI 3L 80A TF AC1500V LS	<b>35089-0080</b>
NH-SI 3L 100A TF AC1500V LS	3L	100	3	NH-SI 3L 100A TF AC1500V LS	<b>35089-0090</b>
NH-SI 3L 125A TF AC1500V LS	3L	125	3	NH-SI 3L 125A TF AC1500V LS	<b>35089-0100</b>
NH-SI 3L 160A TF AC1500V LS	3L	160	3	NH-SI 3L 160A TF AC1500V LS	<b>35089-0110</b>
NH-SI 3L 200A TF AC1500V LS	3L	200	3	NH-SI 3L 200A TF AC1500V LS	<b>35089-0120</b>
NH-SI 3L 224A TF AC1500V LS	3L	224	3	NH-SI 3L 224A TF AC1500V LS	<b>35089-0130</b>
NH-SI 3L 250A TF AC1500V LS	3L	250	3	NH-SI 3L 250A TF AC1500V LS	<b>35089-0140</b>
NH-SI 3L 300A TF AC1500V LS	3L	300	3	NH-SI 3L 300A TF AC1500V LS	<b>35089-0150</b>
NH-SI 3L 315A TF AC1500V LS	3L	315	3	NH-SI 3L 315A TF AC1500V LS	<b>35089-0160</b>
NH-SI 3L 355A TF AC1500V LS	3L	355	3	NH-SI 3L 355A TF AC1500V LS	<b>35089-0170</b>



35091-0190

### NH Fuse-Links, size 3L, special design

#### Features:

- 1000 V AC (425 – 500 A) and 1500 V AC (10 – 355 A)
- Breaking capacity 10 kA (1500 V AC); 50 kA (1000 V AC), 25 kA, 1000 V DC, 10 – 355 A
- TF acc. to VDE 0660 and DIN 43620-5
- Striker pin for fuse monitoring

Designation	Size	Amps	PU	Product designation	Order no.
NH-SI 3L 10A TF AC1500V SM	3L	10	3	NH-SI 3L 10A TF AC1500V SM	<b>35091-0010</b>
NH-SI 3L 16A TF AC1500V SM	3L	16	3	NH-SI 3L 16A TF AC1500V SM	<b>35091-0020</b>
NH-SI 3L 20A TF AC1500V SM	3L	20	3	NH-SI 3L 20A TF AC1500V SM	<b>35091-0030</b>
NH-SI 3L 25A TF AC1500V SM	3L	25	3	NH-SI 3L 25A TF AC1500V SM	<b>35091-0040</b>
NH-SI 3L 35A TF AC1500V SM	3L	35	3	NH-SI 3L 35A TF AC1500V SM	<b>35091-0050</b>
NH-SI 3L 50A TF AC1500V SM	3L	50	3	NH-SI 3L 50A TF AC1500V SM	<b>35091-0060</b>
NH-SI 3L 63A TF AC1500V SM	3L	63	3	NH-SI 3L 63A TF AC1500V SM	<b>35091-0070</b>
NH-SI 3L 80A TF AC1500V SM	3L	80	3	A NH-SI 3L 80A TF AC1500V SM	<b>35091-0080</b>
NH-SI 3L 100A TF AC1500V SM	3L	100	3	NH-SI 3L 100A TF AC1500V SM	<b>35091-0090</b>
NH-SI 3L 125A TF AC1500V SM	3L	125	1	NH-SI 3L 125A TF AC1500V SM	<b>35091-0100</b>
NH-SI 3L 160A TF AC1500V SM	3L	160	3	A NH-SI 3L 160A TF AC1500V SM	<b>35091-0110</b>
NH-SI 3L 200A TF AC1500V SM	3L	200	3	NH-SI 3L 200A TF AC1500V SM	<b>35091-0120</b>
NH-SI 3L 224A TF AC1500V SM	3L	224	3	NH-SI 3L 224A TF AC1500V SM	<b>35091-0130</b>
NH-SI 3L 250A TF AC1500V SM	3L	250	3	NH-SI 3L 250A TF AC1500V SM	<b>35091-0140</b>
NH-SI 3L 300A TF AC1500V SM	3L	300	3	NH-SI 3L 300A TF AC1500V SM	<b>35091-0150</b>
NH-SI 3L 315A TF AC1500V SM	3L	315	3	NH-SI 3L 315A TF AC1500V SM	<b>35091-0160</b>
NH-SI 3L 355A TF AC1500V SM	3L	355	3	NH-SI 3L 355A TF AC1500V SM	<b>35091-0170</b>

## NH Fuse-Links for DC applications up to 80 V, series TPS

### TPS Fault Terminator

TPS 00/60 – 600 A

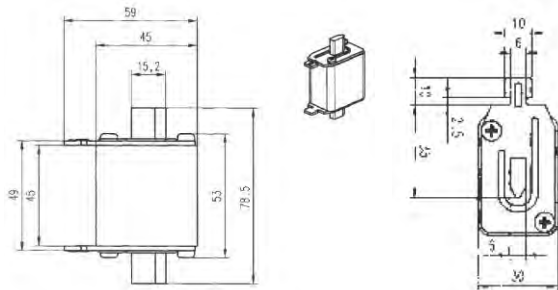

TPS 00/60 – 600 A with striker

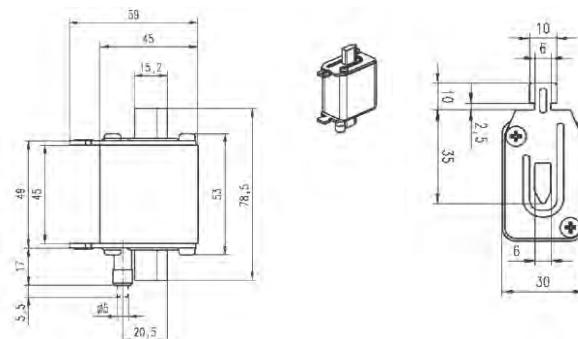

TPS 2/800 – 1600 A

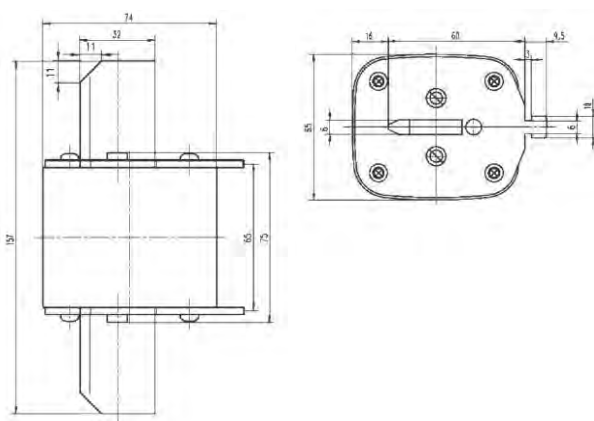

Rated power dissipation in Watts of TPS Fault Terminator size 00

$I_n$ [A]	Fuse-link	Fuse-link with switch
60	4,5	5
80	5	5,5
100	6,5	7,8
150	10	13
200	12	17
250	13	21
300	16	23
400	19,5	32
500	26	43
600	29	54

Rated power dissipation in Watts of TPS Fault Terminator size 2

$I_n$ [A]	Fuse-link	Fuse-link with switch
800	43	65
1000	57	89
1200	64	113
1600	95	155

## Products for DC applications max. 550 V

### 1. Application

- Defined point of intersection between battery and UPS.
- Isolation of the battery during service and maintenance work.
- Protection of the battery against over-heating and mechanical damage in the case of short-circuits.

### 2. Selection criteria for EFEN battery switches and battery fuses

- Single-pole NH load-break switches in sizes from 00 to 4a are specifically suited to isolate and safeguard backup batteries in UPS applications. General-purpose line protection fuses are usually not suitable for use in these applications. Fast-acting fuses must be used. The extra heat coming from these fuse-links has to be taken into account when selecting suitable fuse switches. EFEN uses highly temperature-resistant materials that allow for optimum space utilization and reliable operation.
- Specific care must be taken to select the correct fuse-links for battery protection. Fuse elements for UPS systems must be resistant to ageing in order to prevent premature tripping under permissible load.
- The fuse-link characteristics must be carefully selected according to the UPS system and the battery rating in order to provide reliable full-range protection of the battery. EFEN offers expert

support in this process. Please *fill in and return the questionnaire* (see next page).

### 3. Features and benefits of EFEN battery switches and battery fuse-links for UPS.

- EFEN battery fuse-links provide superior short-circuit protection.
- Silver fuse elements resistant to ageing prevent premature inadvertent tripping.
- Low power dissipation prevents overheating of plastic components.
- Parallel contact isolation with two arcing chambers provides excellent DC breaking capacity.
- High thermal stability of plastics prevents overheating even under overload conditions.
- A complete range of fuse switches and fuse-links for optimal protection of all industry-standard UPS systems up to 550 V battery voltage.

# NH Fuse-Links for DC applications up to 550 V

## Questionnaire – EFEN battery-switches and battery-fuses for UPS systems

Company:

Contact person:

Phone no. for technical information:

### 1. UPS system

1.1 Manufacturer:

1.2 Type:

1.3 Output:

1.4 Power factor:

1.5 Efficiency:

1.6 DC circuit voltage:

1.7 Acceptable overload:

### 2. Battery

2.1 Manufacturer:

2.2 Type:

2.3 Rated voltage:

2.4 Capacity:

2.5 Number of blocks:

2.6 Battery layout:

- a) one string       b) circuit with a neutral point       c) two separately protected strings       d) other

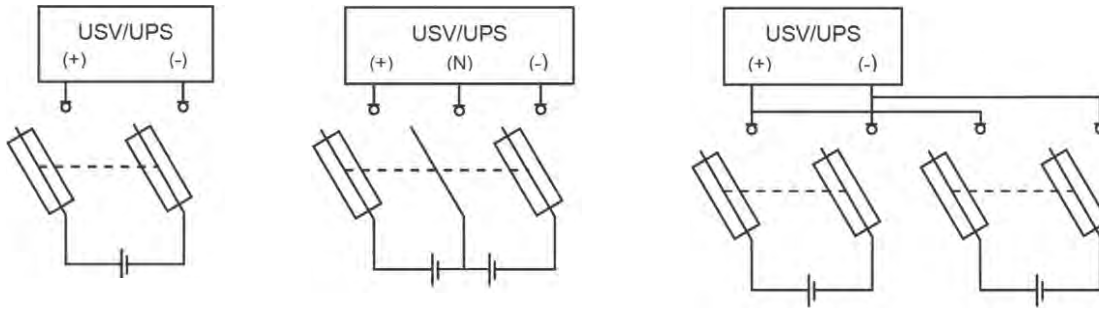

2.7 Operating time:

2.8 Final discharge voltage (at the end of operating time):

2.9 Acceptable overload:

Place, date:

Completed by:   
(Signature)

## NH Fuse-Links for DC applications up to 550 V

### NH battery fuses DC 550 V for uninterruptible power supplies (UPS)

Description	Size	Type	Designation	PU	Weight in kg	Order no.
NH battery fuse	00	00 E	NH-BATTERIESICHERUNG 00 E	3	0,148	35177-0010
NH battery fuse	00	00 G	NH-BATTERIESICHERUNG 00 G	3	0,148	35177-0030
NH battery fuse	00	00 H	NH-BATTERIESICHERUNG 00 H	3	0,148	35177-0040
NH battery fuse	00	00 A	NH-BATTERIESICHERUNG 00 A	3	0,148	35177-0050
NH battery fuse	00	00 B	NH-BATTERIESICHERUNG 00 B	3	0,148	35177-0060
NH battery fuse	00	00 C	NH-BATTERIESICHERUNG 00 C	3	0,148	35177-0070
NH battery fuse	00	00 D	NH-BATTERIESICHERUNG 00 D	3	0,148	35177-0080
NH battery fuse	2C	1 A	NH-BATTERIESICHERUNG 1 A	3	0,398	35178-0010
NH battery fuse	2C	1 B	NH-BATTERIESICHERUNG 1 B	3	0,398	35178-0020
NH battery fuse	2C	1 C	NH-BATTERIESICHERUNG 1 C	3	0,398	35178-0030
NH battery fuse	2	2 A	NH-BATTERIESICHERUNG 2 A	3	0,636	35179-0010
NH battery fuse	2	2 B	NH-BATTERIESICHERUNG 2 B	3	0,636	35179-0020
NH battery fuse	3	3 A	NH-BATTERIESICHERUNG 3 A	1	0,915	35180-0010
NH battery fuse	3	3 B	NH-BATTERIESICHERUNG 3 B	1	0,915	35180-0020
NH battery fuse	3	3 C	NH-BATTERIESICHERUNG 3 C	1	0,915	35180-0030
NH battery fuse	4a	4 C	NH-BATTERIESICHERUNG 4 C	1	2,589	35183-0020
NH battery fuse	4a	4 D	NH-BATTERIESICHERUNG 4 D	1	2,589	35183-0030
NH battery fuse	4a	4 E	NH-BATTERIESICHERUNG 4 E	1	2,589	35183-0040

\* Size 2 (compact design 2/1)

Size	a <sub>1</sub>	a <sub>2</sub>	b	c	e <sub>1</sub>	e <sub>2</sub>	f	g
00	78,5	53	15	35	40	28	12,5	47
2C	150	71	20,2	48	50	50	10	65
2	150	71	26,2	48	58	58	14,5	65
3	150	72	40	60	70	70	15	65
4a	200	98	50	85	110	102	28	87

### Battery switches and battery fuses VDE 0660 T107

#### System

EFEN offers a complete range of single-pole compact load-break switches that are specifically designed for an operating voltage of 550 V DC as is typical for uninterruptible power supplies. These load-break switches protect batteries and battery-supplied circuits, representing the interface and isolating the system e.g. for maintenance purposes. Fuse-monitoring devices, strikers and a multitude of accessories are available.

#### Support

The isolation of a battery system in the event of a short-circuit must be precisely tuned to its capacity and maintenance concept. Fast-acting battery fuses selected in coordination with EFEN ensure reliable protection.

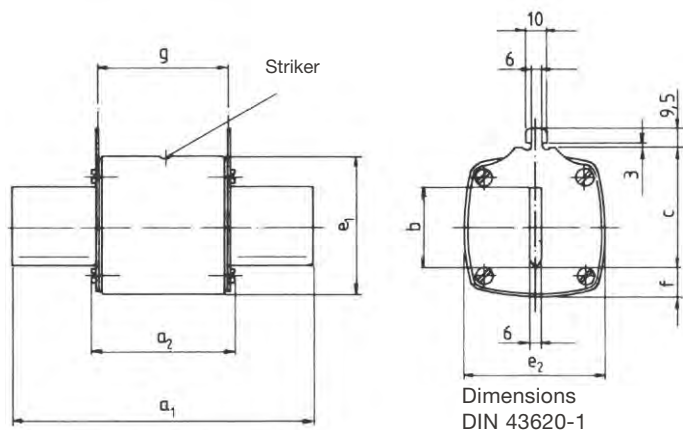

## NH Accessories

► Technical data, page 59



36022-0010

### NH fuse handles acc. to VDE 0636 T 201 and IEC 60269-2-1 for NH fuse-links and solid links

#### Features:

- Acc. to VDE 0636 T 201, IEC 60269-2-1
- For NH fuse-links and solid links

Designation	Size	Amps	PU	Product designation	Order no.
With leather cuff, 352 mm long	00-3		3	NH-GRIFF MIT LEDERSTULPE	<b>36022-0010</b>
With hand protection, without cuff	00-3		10	NH-HANDGRIFF GR.00-3	<b>36020-0010</b>
Special variant for NH fuse-links or solid links with 120 mm gripping lug spacing, 1500 V	3L		4	NH-HANDGRIFF GR.3 1500V	<b>36018-0010</b>



36008-0010

### NH solid link, size 00 – 4a, non-insulated metal gripping lugs

#### Features:

- Non-insulated metal gripping lugs

Designation	Size	Amps	PU	Product designation	Order no.
NH solid link	00	160	15	TRENNMESSER GR.00	<b>36008-0010</b>
NH solid link	00	250	15	TRENNMESSER GR.00 250A	<b>36115-0010</b>
NH solid link	0	160	15	TRENNMESSER GR.0	<b>36009-0010</b>
NH solid link	1	250	9	TRENNMESSER GR.1	<b>36010-0010</b>
NH solid link	2	400	6	TRENNMESSER GR.2 NR	<b>36011-0010</b>
NH solid link	3	630	6	TRENNMESSER GR.3	<b>36012-0010</b>
NH solid link	3	1000	6	TRENNMESSER GR.3 1000A / 1250A	<b>36012-0020</b>
NH solid link	4	1250	10	TRENNMESSER GR.4	<b>36013-0010</b>
NH solid link	4a	1600	6	TRENNMESSER GR.4A	<b>36014-0010</b>



36139-0010

### NH solid link, size 00 – 3a, insulated gripping lugs

#### Features:

- Insulated gripping lug

Designation	Size	Amps	PU	Product designation	Order no.
NH solid link, insulated gripping lug	00	160	12	TRENNMESSER GR.00 160A LP	<b>36139-0010</b>
NH solid link, insulated gripping lug	0	160	6	TRENNMESSER GR.0 160A LP	<b>36140-0010</b>
NH solid link, insulated gripping lug	1	250	12	TRENNMESSER GR.1 250A LP	<b>36141-0010</b>
NH solid link, insulated gripping lug	2	400	6	TRENNMESSER GR.2 400A LP	<b>36142-0010</b>
NH solid link, insulated gripping lug	3	630	6	TRENNMESSER GR.3 630A LP	<b>36143-0010</b>
NH solid link, insulated gripping lug	3	1000	3	TRENNMESSER GR.3 1000A LP	<b>36144-0010</b>
NH solid link, insulated gripping lug	3L	1000	15	TRENNMESSER GR.3L 1000A LP	<b>36015-0020</b>
TPS solid link for up to 600 A	00	600	1	TRENNMESSER TPS 00/600	<b>36917-0010</b>
TPS solid link for up to 1600 A	2	1600	1	TRENNMESSER TPS 2/1600	<b>36918-0010</b>

## NH Accessories

### NH fuse handles

Acc. to VDE 0680-4, DIN 43620-4, IEC 60269-2-1 for NH fuse-links and solid links.

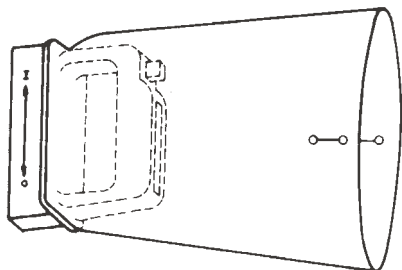

Description	PU	Weight	Order no.
<b>Fuse handle for NH Fuse-Links</b> DIN 43620-1 and DIN VDE 0636-201, size 00 – 3 (can also be used for size 4) with hand protection, without cuff	10	0,208	<b>36020-0010</b>
<b>Fuse handle for NH Fuse-Links</b> DIN 43620-1 and DIN VDE 0636-201, size 00 – 3 (can also be used for size 4) with leather cuff, 352 mm long	3	0,384	<b>36022-0010</b>
<b>Special fuse handle for NH Fuse-Links</b> with a gripping-lug spacing of 120 mm, 1500 V	4	0,301	<b>36018-0010</b>

### NH solid link, size 00 – 4a

NH solid links are suitable for NH fuse-bases acc. to DIN 43620-3 and VDE 0636-201 as well as NH fuse-switches and isolating switches of the corresponding sizes.

Metal gripping lugs

Insulated gripping lugs

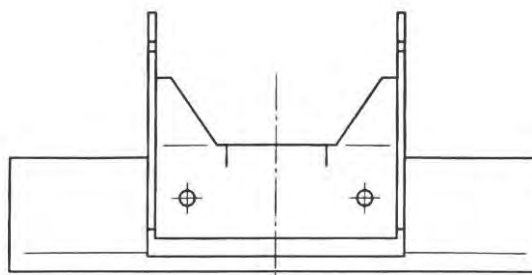
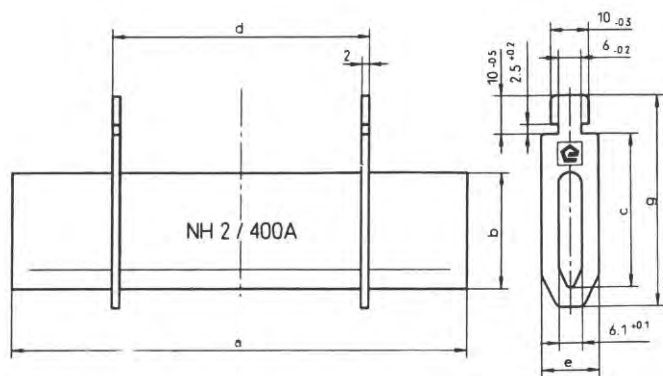

Size	Amps	V	Dimensions						Weight	PU	Metal gripping lugs	Weight	PU	Insulated gripping lugs
			a	b	c	d	g	e			Order no.			Order no.
		<b>0,00</b>												
<b>00</b>	160	0,00	77	15	35	47	49	17	0,07	15	<b>36008-0010</b>	0,05	12	<b>36139-0010</b>
<b>0</b>	160	0,00	77	15	35	47	49	17	0,10	10	<b>36009-0010</b>	0,10	6	<b>36140-0010</b>
<b>1</b>	250	0,00	122,5	15	35	65	56	17	0,15	9	<b>36010-0010</b>	0,15	12	<b>36141-0010</b>
<b>2</b>	400	0,00	132,5	20	40	65	64	20	0,21	6	<b>36011-0010</b>	0,25	6	<b>36142-0010</b>
<b>3</b>	630	0,00	147,5	25	48	65	76	20	0,27	6	<b>36012-0010</b>	0,25	6	<b>36143-0010</b>
<b>3</b>	1000	0,00	147,5	32	60	65	76	20	0,27	6	<b>36012-0020</b>	0,25	6	<b>36144-0010</b>
<b>3L</b>	1000	0,00	147,5	32	60	65	70	20	-	-	-	0,35	10	<b>36015-0020</b>
<b>4</b>	1250	0,00	203	32	60	120	96	96	0,60	10	<b>36013-0010</b>	-	-	-
<b>4a</b>	1600	0,00	200	50	85	65	96	25	0,59	6	<b>36014-0010</b>	-	-	-

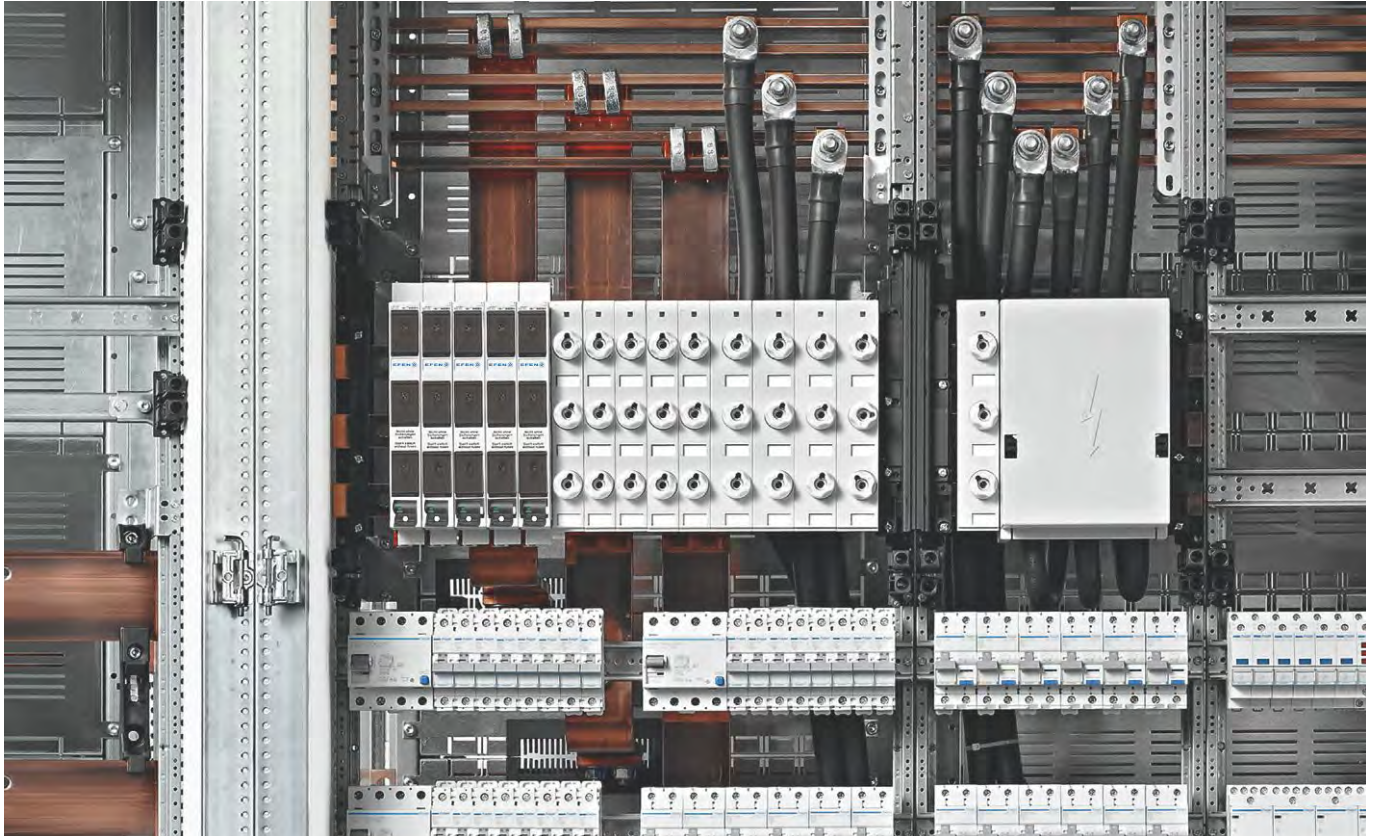

## D Fuse-Links

The D0 Fuse-Links offer protection within the smallest space and, thanks to state-of-the-art distribution components, perfectly integrate into future systems.

### System

The D0 fuse systems are characterized by a high level of protection against accidental contact. Ceramic gage rings in the fuse base - prevent the installation of incorrect fuse elements in the critical range above 10 A. EFEN offers a wide range of D0 fuse-links from 2 to 63 A.

### Features

Thanks to the uniform rated voltage of 500 V for direct and alternating current and due to the high breaking capacity of AC 50 kA and DC 8 kA, the D0 system is universally suited for installation in buildings and industrial applications.



## D Fuse-Links

D Fuse-Links E14, E16, E18, E27 and E33	page 62
D-type gauge rings E16, E27 and E33	page 63
D0-type gauge pieces E14 and E18	page 64
D-type screw gauge pieces E27 and E33	page 64
D-type accessories	page 65
Technical data	page 66

### D0 Fuse-Links



### D0 Fuse-Links DII-DIII



### D0 Fuse-Links E16

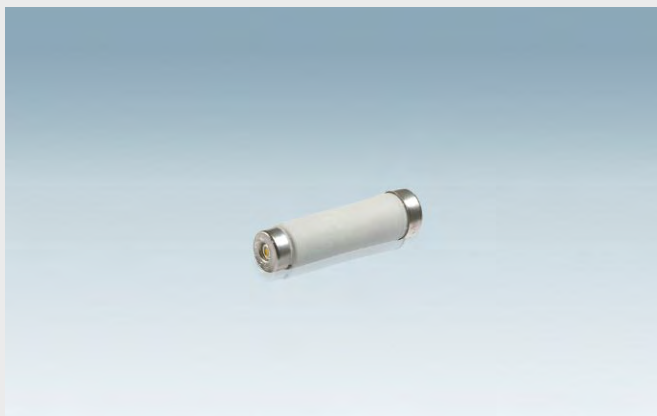

### Ring-type, D0-type and D0 screw gauge pieces



## D Fuse-Links

- Fuse-links D01 – DII
- Category gG
- Rated voltage:  
400 V AC / 250 V DC
- Rated breaking capacity:  
50 kA / 400 V AC,  
8 kA / 250 V DC
- Standards EC 60269, EN 60269,  
DIN 49522, VDE 0636-T41

► Technical data, page 67



55021-0020

### D0 Fuse-Links

#### Features:

- Compliant with VDE 0636 part 21, 31, 41, IEC 60269-2-1, 6029-3
- VDE approval
- Utilization category gG
- Rated voltage AC 400 (440) V, DC 250 V

Designation	Amps	PU	Product designation	Order no.
D-SI D01 E14 2A gG	2	10	D-SI D01 E14 2A gG	<b>55021-0020</b>
D-SI D01 E14 4A gG	4	10	D-SI D01 E14 4A gG	<b>55021-0040</b>
D-SI D01 E14 6A gG	6	10	D-SI D01 E14 6A gG	<b>55021-0060</b>
D-SI D01 E14 10A gG	10	10	D-SI D01 E14 10A gG	<b>55021-0100</b>
D-SI D01 E14 16A gG	16	10	D-SI D01 E14 16A gG	<b>55021-0160</b>
D-SI D02 E18 20A gG	20	10	D-SI D02 E18 20A gG	<b>55022-0200</b>
D-SI D02 E18 25A gG	25	10	D-SI D02 E18 25A gG	<b>55022-0250</b>
D-SI D02 E18 32A gG	32	10	D-SI D02 E18 32A gG	<b>55022-0320</b>
D-SI D02 E18 35A gG	35	10	D-SI D02 E18 35A gG	<b>55022-0350</b>
D-SI D02 E18 40A gG	40	10	D-SI D02 E18 40A gG	<b>55022-0400</b>
D-SI D02 E18 50A gG	50	10	D-SI D02 E18 50A gG	<b>55022-0500</b>
D-SI D02 E18 63A gG	63	10	D-SI D02 E18 63A gG	<b>55022-0630</b>



55015-0100

### D Fuse-Links DII-DIII

#### Features:

- Slow-blow characteristic acc. to DIN 49515, VDE 0636
- Characteristic gG acc. to VDE 0636, EN 60269
- VDE approval, rated voltage AC 500 V

Designation	Amps	PU	Product designation	Order no.
D-SI DII E27 2A gG	2	100	D-SI DII E27 2A gG	<b>55015-0020</b>
D-SI DII E27 10A gG	10	100	D-SI DII E27 10A gG	<b>55015-0100</b>
D-SI DII E27 16A gG	16	100	D-SI DII E27 16A gG	<b>55015-0160</b>
D-SI DII E27 20A gG	20	100	D-SI DII E27 20A gG	<b>55015-0200</b>
D-SI DII E27 25A gG	25	100	D-SI DII E27 25A gG	<b>55015-0250</b>
D-SI DIII E33 35A gG	35	100	D-SI DIII E33 35A gG	<b>55016-0350</b>
D-SI DIII E33 50A gG	50	100	D-SI DIII E33 50A gG	<b>55016-0500</b>
D-SI DIII E33 63A gG	63	100	D-SI DIII E33 63A gG	<b>55016-0630</b>



55000-0250

### D Fuse-Links E16

#### Features:

- DIN 49360, 500 V
- Fast-acting or slow-blow
- Variant: Ceramic base with nickel-plated brass contacts
- Colored indicator

Designation	Amps	PU	Product designation	Order no.
D-SI E16 2A F	2	20	D-SI E16 2A F	<b>55000-0020</b>
D-SI E16 4A F	4	20	D-SI E16 4A F	<b>55000-0040</b>
D-SI E16 6A F	6	20	D-SI E16 6A F	<b>55000-0060</b>
D-SI E16 10A F	10	20	D-SI E16 10A F	<b>55000-0100</b>
D-SI E16 16A F	16	20	D-SI E16 16A F	<b>55000-0160</b>
D-SI E16 20A F	20	20	D-SI E16 20A F	<b>55000-0200</b>
D-SI E16 25A F	25	20	D-SI E16 25A F	<b>55000-0250</b>
A D-SI E16 2A T	2	20	A D-SI E16 2A T	<b>55001-0020</b>
A D-SI E16 4A T	4	20	A D-SI E16 4A T	<b>55001-0040</b>
A D-SI E16 6A T	6	20	A D-SI E16 6A T	<b>55001-0060</b>
A D-SI E16 10A T	10	20	A D-SI E16 10A T	<b>55001-0100</b>
A D-SI E16 16A T	16	20	A D-SI E16 16A T	<b>55001-0160</b>
A D-SI E16 20A T	20	20	A D-SI E16 20A T	<b>55001-0200</b>
A D-SI E16 25A T	25	20	A D-SI E16 25A T	<b>55001-0250</b>

## D Fuse-Links

► Technical data, page 66



58002-0160

### D-type ceramic gauge rings acc. to DIN 49360 and DIN 49362

#### Features:

- Ceramic
- E16
- 2 A to 16 A

Designation	Amps	PU	Product designation	Order no.
D-type ceramic gauge ring insert E16 2A	2	100	D-PASSEINSATZ E16 2A KER	<b>58002-0020</b>
D-type ceramic gauge ring insert E16 4A	4	100	D-PASSEINSATZ E16 4A KER	<b>58002-0040</b>
D-type ceramic gauge ring insert E16 6A	6	100	D-PASSEINSATZ E16 6A KER	<b>58002-0060</b>
D-type ceramic gauge ring insert E16 10A	10	100	D-PASSEINSATZ E16 10A KER	<b>58002-0100</b>
D-type ceramic gauge ring insert E16 16A	16	100	D-PASSEINSATZ E16 16A KER	<b>58002-0160</b>



58003-0200

### D-type ceramic gauge ring inserts acc. to DIN 49360 and DIN 49362

#### Features:

- Ceramic
- E16
- 2 A to 16 A

Designation	Amps	PU	Product designation	Order no.
D-type ceramic gauge ring E27 DII 2A	2	100	D-PASSEINSATZ E27 DII 2A KER	<b>58003-0020</b>
D-type ceramic gauge ring E27 DII 4A	4	100	D-PASSEINSATZ E27 DII 4A KER	<b>58003-0040</b>
D-type ceramic gauge ring E27 DII 6A	6	100	D-PASSEINSATZ E27 DII 6A KER	<b>58003-0060</b>
D-type ceramic gauge ring E27 DII 10A	10	100	D-PASSEINSATZ E27 DII 10A KER	<b>58003-0100</b>
D-type ceramic gauge ring E27 DII 16A	16	100	D-PASSEINSATZ E27 DII 16A KER	<b>58003-0160</b>
D-type ceramic gauge ring E27 DII 20A	20	100	D-PASSEINSATZ E27 DII 20A KER	<b>58003-0200</b>
D-TYPE CERAMIC GAUGE RING E27 DII 25A	50		D-PASSEINSATZ E27 DII 25A KER	<b>58003-0250</b>



58004-0350

### D-type ceramic gauge ring E27 DII 25A

#### Features:

- Ceramic
- E33
- 2 A to 35 A

Designation	Amps	PU	Product designation	Order no.
D-type ceramic gauge ring E33 DIII 2A	2	50	D-PASSEINSATZ E33 DIII 2A KER	<b>58004-0020</b>
D-type ceramic gauge ring E33 DIII 4A	4	50	D-PASSEINSATZ E33 DIII 4A KER	<b>58004-0040</b>
D-type ceramic gauge ring E33 DIII 6A	6	50	D-PASSEINSATZ E33 DIII 6A KER	<b>58004-0060</b>
D-type ceramic gauge ring E33 DIII 10A	10	50	D-PASSEINSATZ E33 DIII 10A KER	<b>58004-0100</b>
D-type ceramic gauge ring E33 DIII 16A	16	50	D-PASSEINSATZ E33 DIII 16A KER	<b>58004-0160</b>
D-type ceramic gauge ring E33 DIII 20A	20	50	D-PASSEINSATZ E33 DIII 20A KER	<b>58004-0200</b>
D-type ceramic gauge ring E33 DIII 25A	25	50	D-PASSEINSATZ E33 DIII 25A KER	<b>58004-0250</b>
D-type ceramic gauge ring E33 DIII 35A	35	50	D-PASSEINSATZ E33 DIII 35A KER	<b>58004-0350</b>
D-type ceramic gauge ring E33 DIII 50A	50	50	D-PASSEINSATZ E33 DIII 50A KER	<b>58004-0500</b>
D-type ceramic gauge ring E33 DIII 63A	63	50	D-PASSEINSATZ E33 DIII 63A KER	<b>58004-0630</b>

## D-type gauge pieces, D-type screw-in gauge piece

► Technical data - on demand



58006-0200

**D0-type gauge pieces**  
 acc. to 49523 for over-voltage protection

- Features:**
- E14, E18, D03
  - 2 A to 80 A

Designation	Amps	PU	Product designation	Order no.
D-type gauge piece D01 E14 PH01 2A	2	100	D-PASSHÜLSE D01 E14 PH01 2A ROSA	<b>58005-0020</b>
D-type gauge piece D01 E14 PH01 4A	4	100	D-PASSHÜLSE D01 E14 PH01 4A BRAUN	<b>58005-0040</b>
D-type gauge piece D01 E14 PH01 6A	6	100	D-PASSHÜLSE D01 E14 PH01 6A GRÜN	<b>58005-0060</b>
D-type gauge piece D01 E14 PH01 10A	10	100	D-PASSHÜLSE D01 E14 PH01 10A ROT	<b>58005-0100</b>
D-type gauge piece D01 E18 PH02 4A	4	100	D-PASSHÜLSE D02 E18 PH02 4A BRAUN	<b>58006-0040</b>
D-type gauge piece D01 E18 PH02 6A	6	100	D-PASSHÜLSE D02 E18 PH02 6A GRÜN	<b>58006-0060</b>
D-type gauge piece D01 E18 PH02 10A	10	100	D-PASSHÜLSE D02 E18 PH02 10A ROT	<b>58006-0100</b>
D-type gauge piece D01 E18 PH02 16A	16	100	D-PASSHÜLSE D02 E18 PH02 16A GRAU	<b>58006-0160</b>
D-type gauge piece D01 E18 PH02 20A	20	100	D-PASSHÜLSE D02 E18 PH02 20A BLAU	<b>58006-0200</b>
D-type gauge piece D01 E18 PH02 25A	25	100	D-PASSHÜLSE D02 E18 PH02 25A GELB	<b>58006-0250</b>
D-type gauge piece D01 E18 PH02 35A	35	100	D-PASSHÜLSE D02 E18 PH02 35A SCHWARZ	<b>58006-0350</b>
D-type gauge piece D01 E18 PH02 50A	50	100	D-PASSHÜLSE D02 E18 PH02 50A WEISS	<b>58006-0500</b>



58020-0020

**D-type screw gauge pieces**  
 acc. to DIN 49516 for over-voltage protection

- Features:**
- Ceramic
  - E27 – E33
  - 2 A to 63 A

Designation	Amps	PU	Product designation	Order no.
D-type screw gauge piece E27 20A	20	100	D-SCHRAUBPASSEINSATZ E27 20A	<b>58020-0200</b>
D-type screw gauge piece E27 25A	25	100	D-SCHRAUBPASSEINSATZ E27 25A	<b>58020-0250</b>
D-type screw gauge piece E27 4A	4	100	D-Schraubpasseinsatz E27 4A	<b>58020-3040</b>
D-type screw gauge piece E27 6A	6	100	D-Schraubpasseinsatz E27 6A	<b>58020-3060</b>
D-type screw gauge piece E27 10A	10	100	D-Schraubpasseinsatz E27 10A	<b>58020-3100</b>
D-type screw gauge piece E27 16A	16	100	D-Schraubpasseinsatz E27 16A	<b>58020-3160</b>
D-type screw gauge piece E27 20A	20	100	D-Schraubpasseinsatz E27 20A	<b>58020-3200</b>
D-type screw gauge piece E27 25A	25	100	D-Schraubpasseinsatz E27 25A	<b>58020-3250</b>
D-type screw gauge piece E33 35A	35	100	D-Schraubpasseinsatz E33 35A	<b>58021-3350</b>
D-type screw gauge piece E33 50A	50	100	D-Schraubpasseinsatz E33 50A	<b>58021-3500</b>
D-type screw gauge piece E33 63A	63	100	D-Schraubpasseinsatz E33 63A	<b>58021-3630</b>

# D-type accessories

► Technical data - on demand



58008-0010

## Key for D-type gauge pieces

**Features:**  
- for D01 – D02

Designation	PU	Product designation	Order no.
Key for D-type gauge pieces D01 – D02	1	D-Passeinsatzschlüssel D01-D02	<b>58008-0010</b>



58015-0010

## D0-type special retaining spring

**Features:**  
- Metal

Designation	PU	Product designation	Order no.
D0-type retaining spring D01 in K02	100	D0-HALTEFEDER D01 in K02 RFD02-01	<b>58015-0010</b>

## D-type fuse system

### Type 58002-xxxx

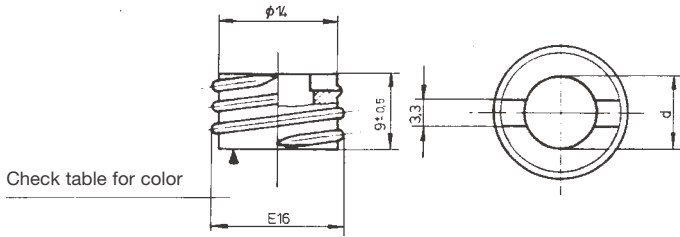

Check table for color

Rated current A		RAL color		Order no.
2	6,3	pink	3014	58002-0020
4		brown	8003	58002-0040
6		green	6010	58002-0060
10	8,5	red	3000	58002-0100
16	10,5	grey	7005	58002-0160

For other types please inquire

### Type 58003-xxxx

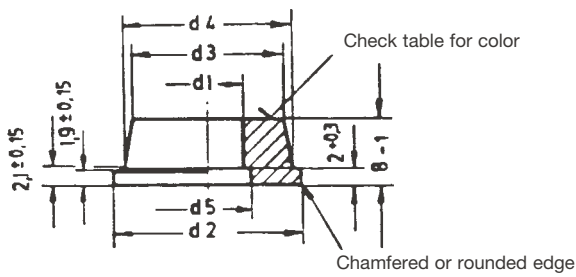

Order no.	Rated current A					Color	
58003-0020	2	6,5	22,5	18,5	20	10	pink
58003-0040	4					brown	
58003-0060	6					green	
58003-0100	10	8,5				12	red
58003-0160	16	10,5				14	grey
58003-0200	20	12,5				15,5	blue

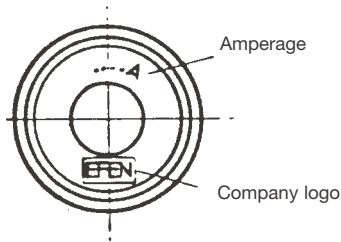

### Type 58004-xxxx

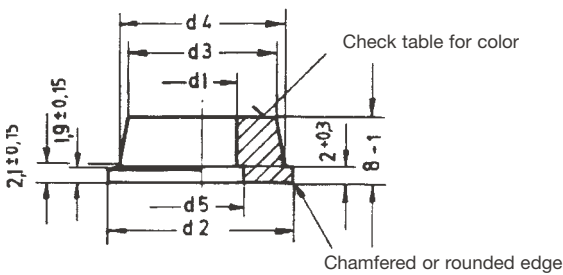

Order no.	Rated current A	d + 0,8 0	d ± 0,5	d ± 0,5	d ± 0,5	d min.	Color
58004-0020	2	6,5	28,5	24,5	26	10	pink
58004-0040	4					brown	
58004-0060	6					green	
58004-0100	10	8,5				12	red
58004-0160	16	10,5				14	grey
58004-0200	20	12,5				16	blue
58004-0250	25	14,5				18	yellow
58004-0350	35	16,5				20	black

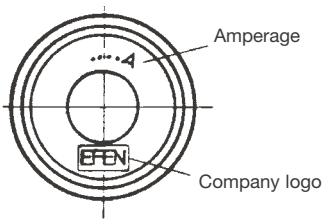

# D-type fuse system

**Current limitation diagram gG/gL 500 V~  
D01, D02, DII, DIII Fuse-Links**

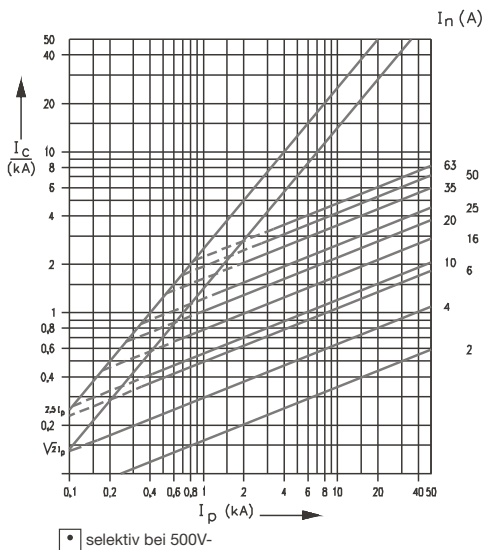

**Selectivity gL/gG fuses  
D01, D02, DII, DIII**

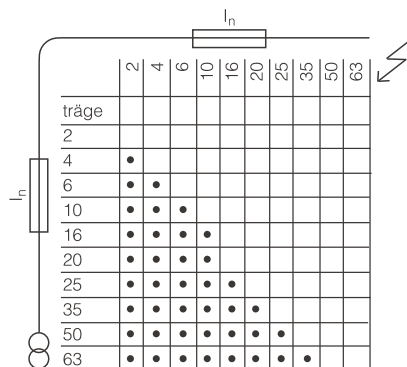

**Power dissipation table  
D01, D02 gG/gL fuses**

	$I_n$	Watt
<b>D01</b>	2A	0,8
	4A	1,1
	6A	1,2
	10A	1,1
	16A	1,7
	20A	1,7
<b>D02</b>	25A	2,3
	35A	2,8
	50A	3,8
	63A	5,0

**DII, DIII gG/gL fuses**

	$I_n$	Watt
<b>DII</b>	2A	1,5
	4A	1,6
	6A	1,8
	10A	1,4
	16A	2,1
	20A	2,2
<b>DIII</b>	25A	3
	35A	4,1
	50A	5
	63A	6,9

**Time-current characteristic D01, D02, DII, DIII gG/gL**

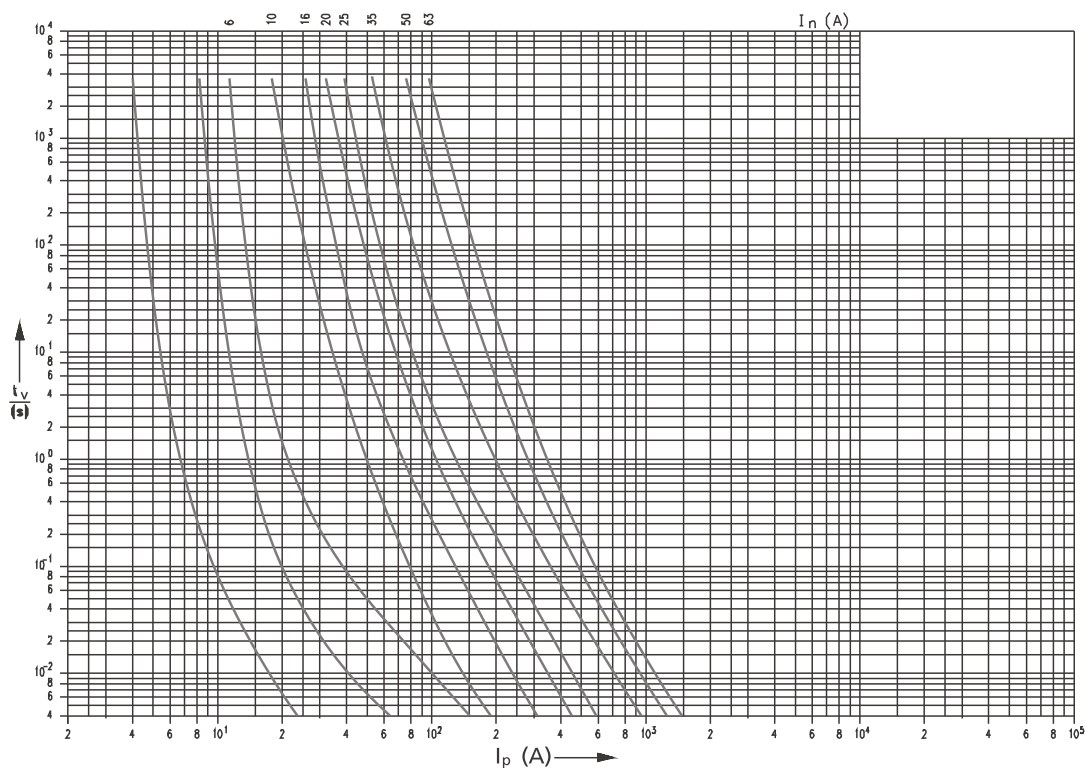



## DC Fuse-Links 10 x 38

Reliable protection of photovoltaic systems against overloads and short-circuits.

### System

The fuse-links 10 x 38 by EFEN are the base line of string protection in photovoltaic systems. Designed for the rated DC voltage of 600 V required for solar modules, these fuses offer reliable protection against overload and short-circuit.

### Features

The compact DC fuses are designed for high breaking currents. They are ideally suited for applications requiring reliable and instant breaking in the event of a failure.



**DC Fuse-Links 10 x 38**

DC Fuse-Links 10 x 38

page 70

Technical data

page 72

**DC Fuse-Links**

for 1000 V with 30 kA breaking capacity



**DC Fuse-Disconnecter**

for optimum line section protection  
see page 136



## DC Fuse-Links 10 x 38

**Application:**

Protection of photovoltaic (PV)  
DC systems against overcurrent  
and short-circuits

► Technical data, page 72



55030-0010

**DC fuse 10 x 38 for 1000 V gPV**

**Features:**

- Rated voltage: 1000 V DC / 600 V DC
- Breaking capacity: 30 kA
- Utilization category: gPV
- IEC 60269-6

Designation	Size	Amps	PU	Product designation	Order no.
SI-10x38 gPV 1000V DC 1A	10 x 38	1	10	SI-10x38 gPV 1000V DC 1A	<b>55030-0010</b>
SI-10x38 gPV 1000V DC 2A	10 x 38	2	10	SI-10x38 gPV 1000V DC 2A	<b>55030-0020</b>
SI-10x38 gPV 1000V DC 3A	10 x 38	3	10	SI-10x38 gPV 1000V DC 3A	<b>55030-0030</b>
SI-10x38 gPV 1000V DC 4A	10 x 38	4	10	SI-10x38 gPV 1000V DC 4A	<b>55030-0040</b>
SI-10x38 gPV 1000V DC 5A	10 x 38	5	10	SI-10x38 gPV 1000V DC 5A	<b>55030-0050</b>
SI-10x38 gPV 1000V DC 6A	10 x 38	6	10	SI-10x38 gPV 1000V DC 6A	<b>55030-0060</b>
SI-10x38 gPV 1000V DC 8A	10 x 38	8	10	SI-10x38 gPV 1000V DC 8A	<b>55030-0080</b>
SI-10x38 gPV 1000V DC 10A	10 x 38	10	10	SI-10x38 gPV 1000V DC 10A	<b>55030-0100</b>
SI-10x38 gPV 1000V DC 12A	10 x 38	12	10	SI-10x38 gPV 1000V DC 12A	<b>55030-0120</b>
SI-10x38 gPV 1000V DC 15A	10 x 38	15	10	SI-10x38 gPV 1000V DC 15A	<b>55030-0150</b>
SI-10x38 gPV 1000V DC 16A	10 x 38	16	10	SI-10x38 gPV 1000V DC 16A	<b>55030-0160</b>
SI-10x38 gPV 1000V DC 20A	10 x 38	20	10	SI-10x38 gPV 1000V DC 20A	<b>55030-0200</b>
SI-10x38 gPV 600V DC 25A	10 x 38	25	10	SI-10x38 gPV 600V DC 25A	<b>55030-0250</b>
SI-10x38 gPV 600V DC 32A	10 x 38	32	10	SI-10x38 gPV 600V DC 32A	<b>55030-0320</b>



## DC Fuse-Links

### Protection of photovoltaic (PV) DC systems against overcurrent and short-circuits

<b>Size</b>	10,3 x 38 mm	
<b>Rated voltage</b>	1000 V DC	600 V DC
<b>Rated current</b>	1 to 20 A	25 to 32 A
<b>Time constant (L/R)</b>	2 ms	
<b>Minimum release current</b>	1,45 x I <sub>n</sub>	
<b>Breaking capacity</b>	30 kA	
<b>Utilization category</b>	gPV	
<b>Temperature</b>	Operating temperature: - 25 °C to + 70 °C	
<b>Without striker pin, without striker</b>		

Rated voltage	Rated current	EAN	Weight	PU	Order no.
1000 V	1 A	4049857117321	7,9 g	10	55030-0010
1000 V	2 A	4049857117345	7,9 g	10	55030-0020
1000 V	3 A	4049857117512	7,9 g	10	55030-0030
1000 V	4 A	4049857117611	7,9 g	10	55030-0040
1000 V	5 A	4049857117635	7,9 g	10	55030-0050
1000 V	6 A	4049857117659	7,9 g	10	55030-0060
1000 V	8 A	4049857117697	7,9 g	10	55030-0080
1000 V	10 A	4049857117703	7,9 g	10	55030-0100
1000 V	12 A	4049857117710	7,9 g	10	55030-0120
1000 V	15 A	4049857117727	7,9 g	10	55030-0150
1000 V	16 A	4049857117857	7,9 g	10	55030-0160
1000 V	20 A	4049857117901	7,9 g	10	55030-0200
600 V	25 A	4049857117918	7,9 g	10	55030-0250
600 V	32 A	4049857117956	7,9 g	10	55030-0320

### Temperature compensation factor (A1): Compensation factors for adjustment to ambient temperature:

Ambient temperature	25 °C	30 °C	40 °C	50 °C	60 °C	70 °C
<b>Rated current</b>	I <sub>n</sub>	0,97 x I <sub>n</sub>	0,92 x I <sub>n</sub>	0,87 x I <sub>n</sub>	0,82 x I <sub>n</sub>	0,76 x I <sub>n</sub>

### Rated output

Rated current (A)	1	2	3	4	5	6	8	10	12	15	16	20	25	32
<b>Power dissipation at 0.7 I<sub>n</sub> (W)</b>	0,31	0,62	0,54	0,73	0,93	0,96	1,02	1,03	1,04	1,07	1,08	1,16	1,10	1,76
<b>Power dissipation at I<sub>n</sub> (W)</b>	0,76	1,54	1,35	1,84	2,22	2,4	2,55	2,58	2,6	2,44	2,7	2,9	2,74	4,4

### Dimensions

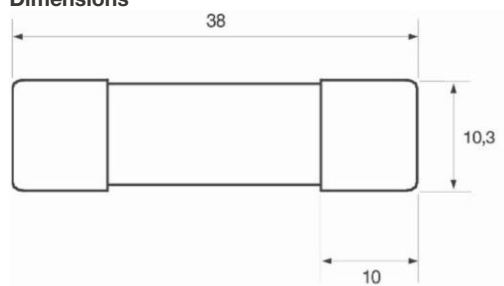

# DC Fuse-Links

Time-current characteristic

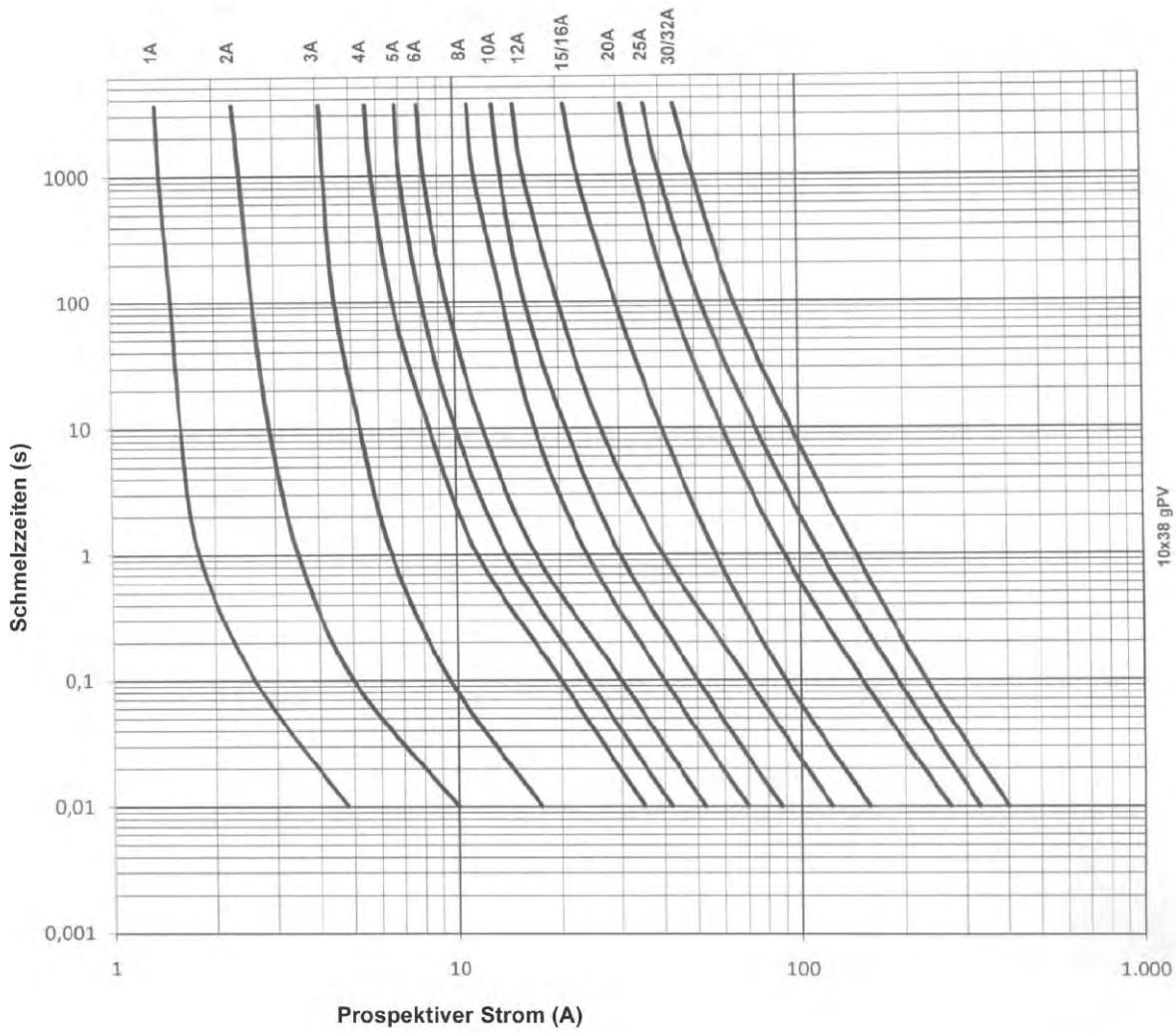



## EFEN HV general-purpose and back-up Fuse-Links

EFEN's general-purpose and back-up Fuse-Links are a reliable safety interface for transformers, capacitors and high-voltage motors. The range comprises types for indoor, outdoor and oil-submerged applications.

### System

EFEN's range of general-purpose and back-up fuse-links is nationally and internationally approved. The HV fuse-links ensure reliable protection of transformers, capacitors and motors.

### Features

The range of HV fuse-links includes variants for indoor and outdoor use as well as oil-submerged applications. A wide range of special-purpose fuse-links – also with special dimensions – and a full range of accessories complements the offer.



## High Voltage Fuse-Links

HV Fuse-Links acc. to VDE 0670 T402 / IEC 60 282-1	page 76
HV Fuse-Links acc. to VDE 0670 T402 / IEC 60 282-1 ÜLA	page 77
HV Fuse-Links acc. to VDE 0670 T402 / IEC 60 282-1 ÜLA+	page 78
HV Fuse-Links acc. to VDE 0670 T4 / IEC 60 282-1	page 79
HV Fuse-Links acc. to VDE 0670 T4 / IEC 60 282-1 ÜLA	page 80
EFEN HV general purpose Fuse-Links acc. to VDE 0670 T402 / IEC 60 282-1	page 78
High-Voltage Fuse-Links for Voltage Transformers (HSW) acc. to VDE 0670 T 402 / IEC 60282-1	page 83
Test device for tripping medium voltage switches	page 83
Accessories for HV Fuse-Links	page 83
Selection tables acc. to T402	page 91
Selection tables acc. to T4	page 94
Technical data	page 84

### Back-Up Fuse-Links

with controlled power dissipation (ÜLA)



### Test device

for tripping medium voltage switches



### Special Version

with threaded stud

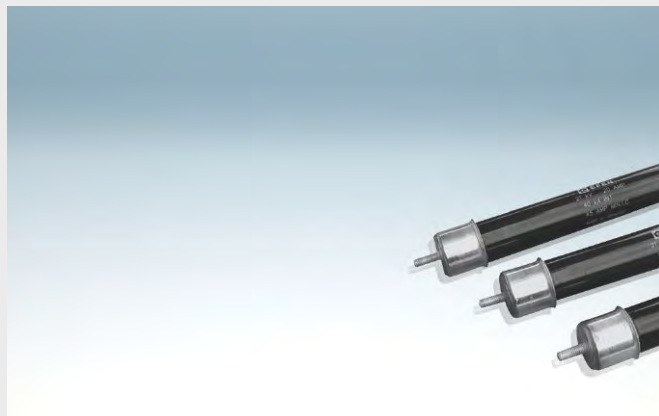

### High-Voltage Fuse-Link

for voltage transformers (HSW)



## HV Fuse-Links acc. to VDE 0670 T402 / IEC 60 282-1

► Technical data, page 98



67140-1000

**HV back-up Fuse-Links acc. to VDE 0670 T402 / IEC 60 282-1**

Designation	Rated volt. kV	Length	Ø	Amps	PU	Product designation	Order no.
HH-SI 3/7,2KV 6,3A FC TA 192/56	3/7,2	192	56	6,3	1	HH-SI 3/7,2KV 6,3A FC TA 192/56	<b>67110-0060</b>
HH-SI 3/7,2KV 10A FC TA 192/56	3/7,2	192	56	10	1	HH-SI 3/7,2KV 10A FC TA 192/56	<b>67110-0100</b>
HH-SI 3/7,2KV 16A FC TA 192/56	3/7,2	192	56	16	1	HH-SI 3/7,2KV 16A FC TA 192/56	<b>67110-0160</b>
HH-SI 3/7,2KV 20A FC TA 192/56	3/7,2	192	56	20	1	HH-SI 3/7,2KV 20A FC TA 192/56	<b>67110-0200</b>
HH-SI 3/7,2KV 25A FC TA 192/56	3/7,2	192	56	25	1	HH-SI 3/7,2KV 25A FC TA 192/56	<b>67110-0250</b>
HH-SI 3/7,2KV 31,5A FC TA 192/56	3/7,2	192	56	31,5	1	HH-SI 3/7,2KV 31,5A FC TA 192/56	<b>67110-0320</b>
HH-SI 3/7,2KV 40A FC TA 192/56	3/7,2	192	56	40	1	HH-SI 3/7,2KV 40A FC TA 192/56	<b>67110-0400</b>
HH-SI 3/7,2KV 50A FC TA 192/56	3/7,2	192	56	50	1	HH-SI 3/7,2KV 50A FC TA 192/56	<b>67110-0500</b>
HH-SI 3/7,2KV 63A FC TA 192/65	3/7,2	192	65	63	1	HH-SI 3/7,2KV 63A FC TA 192/65	<b>67110-0630</b>
HH-SI 3/7,2KV 80A FC TA 192/65	3/7,2	192	65	80	1	HH-SI 3/7,2KV 80A FC TA 192/65	<b>67110-0800</b>
HH-SI 3/7,2KV 100A FC TA 192/78	3/7,2	192	78	100	1	HH-SI 3/7,2KV 100A FC TA 192/78	<b>67110-1000</b>
HH-SI 3/7,2KV 125A FC TA 192/88	3/7,2	192	88	125	1	HH-SI 3/7,2KV 125A FC TA 192/88	<b>67110-1250</b>
HH-SI 3/7,2KV 160A FC TA 192/88	3/7,2	192	88	160	1	HH-SI 3/7,2KV 160A FC TA 192/88	<b>67110-1600</b>
HH-SI 6/12KV 6,3A FC TA 292/56	6/12	292	56	6,3	1	HH-SI 6/12KV 6,3A FC TA 292/56	<b>67120-0060</b>
HH-SI 6/12KV 10A FC TA 292/56	6/12	292	56	10	1	HH-SI 6/12KV 10A FC TA 292/56	<b>67120-0100</b>
HH-SI 6/12KV 16A FC TA 292/56	6/12	292	56	16	1	HH-SI 6/12KV 16A FC TA 292/56	<b>67120-0160</b>
HH-SI 6/12KV 20A FC TA 292/56	6/12	292	56	20	1	HH-SI 6/12KV 20A FC TA 292/56	<b>67120-0200</b>
HH-SI 6/12KV 25A FC TA 292/56	6/12	292	56	25	1	HH-SI 6/12KV 25A FC TA 292/56	<b>67120-0250</b>
HH-SI 6/12KV 31,5A FC TA 292/56	6/12	292	56	31,5	1	HH-SI 6/12KV 31,5A FC TA 292/56	<b>67120-0320</b>
HH-SI 6/12KV 40A FC TA 292/56	6/12	292	56	40	1	HH-SI 6/12KV 40A FC TA 292/56	<b>67120-0400</b>
HH-SI 6/12KV 50A FC TA 292/56	6/12	292	56	50	1	HH-SI 6/12KV 50A FC TA 292/56	<b>67120-0500</b>
HH-SI 6/12KV 63A FC TA 292/65	6/12	292	65	63	1	HH-SI 6/12KV 63A FC TA 292/65	<b>67120-0630</b>
HH-SI 6/12KV 80A FC TA 292/65	6/12	292	65	80	1	HH-SI 6/12KV 80A FC TA 292/65	<b>67120-0800</b>
HH-SI 6/12KV 100A FC TA 292/78	6/12	292	78	100	1	HH-SI 6/12KV 100A FC TA 292/78	<b>67120-1000</b>
HH-SI 6/12KV 125A FC TA 292/88	6/12	292	88	125	1	HH-SI 6/12KV 125A FC TA 292/88	<b>67120-1250</b>
HH-SI 6/12KV 160A FC TA 292/88	6/12	292	88	160	1	HH-SI 6/12KV 160A FC TA 292/88	<b>67120-1600</b>
HH-SI 10/17,5KV 6,3A FC TA 367/56	10/17,5	367	56	6,3	1	HH-SI 10/17,5KV 6,3A FC TA 367/56	<b>67130-0060</b>
HH-SI 10/17,5KV 10A FC TA 367/56	10/17,5	367	56	10	1	HH-SI 10/17,5KV 10A FC TA 367/56	<b>67130-0100</b>
HH-SI 10/17,5KV 16A FC TA 367/56	10/17,5	367	56	16	1	HH-SI 10/17,5KV 16A FC TA 367/56	<b>67130-0160</b>
HH-SI 10/17,5KV 20A FC TA 367/56	10/17,5	367	56	20	1	HH-SI 10/17,5KV 20A FC TA 367/56	<b>67130-0200</b>
HH-SI 10/17,5KV 25A FC TA 367/56	10/17,5	367	56	25	1	HH-SI 10/17,5KV 25A FC TA 367/56	<b>67130-0250</b>
HH-SI 10/17,5KV 30A FC TB 367/56	10/17,5	367	56	30	1	HH-SI 10/17,5KV 30A FC TB 367/56	<b>67130-0300</b>
HH-SI 10/17,5KV 31,5A FC TA 367/56	10/17,5	367	56	31,5	1	HH-SI 10/17,5KV 31,5A FC TA 367/56	<b>67130-0320</b>
HH-SI 10/17,5KV 40A FC TA 367/56	10/17,5	367	56	40	1	HH-SI 10/17,5KV 40A FC TA 367/56	<b>67130-0400</b>
HH-SI 10/17,5KV 50A FC TA 367/78	10/17,5	367	78	50	1	HH-SI 10/17,5KV 50A FC TA 367/78	<b>67130-0500</b>
HH-SI 10/17,5KV 63A FC TA 367/78	10/17,5	367	78	63	1	HH-SI 10/17,5KV 63A FC TA 367/78	<b>67130-0630</b>
HH-SI 10/17,5KV 80A FC TA 367/78	10/17,5	367	78	80	1	HH-SI 10/17,5KV 80A FC TA 367/78	<b>67130-0800</b>
HH-SI 10/17,5KV 100A FC TA 367/88	10/17,5	367	88	100	1	HH-SI 10/17,5KV 100A FC TA 367/88	<b>67130-1000</b>
HH-SI 10/24KV 6,3A FC TA 442/56	10/24	442	56	6,3	1	HH-SI 10/24KV 6,3A FC TA 442/56	<b>67140-0060</b>
HH-SI 10/24KV 10A FC TA 442/56	10/24	442	56	10	1	HH-SI 10/24KV 10A FC TA 442/56	<b>67140-0100</b>
HH-SI 10/24KV 16A FC TA 442/56	10/24	442	56	16	1	HH-SI 10/24KV 16A FC TA 442/56	<b>67140-0160</b>
HH-SI 10/24KV 20A FC TA 442/56	10/24	442	56	20	1	HH-SI 10/24KV 20A FC TA 442/56	<b>67140-0200</b>
HH-SI 10/24KV 25A FC TA 442/56	10/24	442	56	25	1	HH-SI 10/24KV 25A FC TA 442/56	<b>67140-0250</b>
HH-SI 10/24KV 31,5A FC TA 442/56	10/24	442	56	31,5	1	HH-SI 10/24KV 31,5A FC TA 442/56	<b>67140-0320</b>
HH-SI 10/24KV 40A FC TA 442/56	10/24	442	56	40	1	HH-SI 10/24KV 40A FC TA 442/56	<b>67140-0400</b>
HH-SI 10/24KV 50A FC TA 442/65	10/24	442	65	50	1	HH-SI 10/24KV 50A FC TA 442/65	<b>67140-0500</b>
HH-SI 10/24KV 63A FC TA 442/65	10/24	442	65	63	1	HH-SI 10/24KV 63A FC TA 442/65	<b>67140-0630</b>
HH-SI 10/24KV 80A FC TA 442/65	10/24	442	65	80	1	HH-SI 10/24KV 80A FC TA 442/65	<b>67140-0800</b>
HH-SI 10/24KV 100A FC TA 442/88	10/24	442	88	100	1	HH-SI 10/24KV 100A FC TA 442/88	<b>67140-1000</b>

# HV Fuse-Links acc. to VDE 0670 T402 / IEC 60 282-1

► Technical data, page 101

## HV back-up Fuse-Links acc. to VDE 0670 T402 / IEC 60 282-1

Designation	Rated volt. kV	Length Ø	Amps PU	Product designation	Order no.
HH-SI 20/36KV 6,3A FC TA 537/56	20/36	537 56	6,3 1	HH-SI 20/36KV 6,3A FC TA 537/56	<b>67150-0060</b>
HH-SI 20/36KV 10A FC TA 537/56	20/36	537 56	10 1	HH-SI 20/36KV 10A FC TA 537/56	<b>67150-0100</b>
HH-SI 20/36KV 16A FC TA 537/56	20/36	537 56	16 1	HH-SI 20/36KV 16A FC TA 537/56	<b>67150-0160</b>
HH-SI 20/36KV 20A FC TA 537/56	20/36	537 56	20 1	HH-SI 20/36KV 20A FC TA 537/56	<b>67150-0200</b>
HH-SI 20/36KV 25A FC TA 537/56	20/36	537 56	25 1	HH-SI 20/36KV 25A FC TA 537/56	<b>67150-0250</b>
HH-SI 20/36KV 31,5A FC TA 537/65	20/36	537 65	31,5 1	HH-SI 20/36KV 31,5A FC TA 537/65	<b>67150-0320</b>
HH-SI 20/36KV 40A FC TA 537/65	20/36	537 65	40 1	HH-SI 20/36KV 40A FC TA 537/65	<b>67150-0400</b>
HH-SI 20/36KV 50A FC TA 537/88	20/36	537 88	50 1	HH-SI 20/36KV 50A FC TA 537/88	<b>67150-0500</b>
HH-SI 20/36KV 63A FC TA 537/88	20/36	537 88	63 1	HH-SI 20/36KV 63A FC TA 537/88	<b>67150-0630</b>

## HV back-up Fuse-Links acc. to VDE 0670 T402 / IEC 60 282-1 with controlled power dissipation (ÜLA)

Designation	Rated volt. kV	Length Ø	Amps PU	Product designation	Order no.
HH-SI 6/12KV 10A FC ÜLA 292/56	6/12	292 56	10 1	HH-SI 6/12KV 10A FC ÜLA 292/56	<b>67520-0100</b>
HH-SI 6/12KV 16A FC ÜLA 292/56	6/12	292 56	16 1	HH-SI 6/12KV 16A FC ÜLA 292/56	<b>67520-0160</b>
HH-SI 6/12KV 20A FC ÜLA 292/56	6/12	292 56	20 1	HH-SI 6/12KV 20A FC ÜLA 292/56	<b>67520-0200</b>
HH-SI 6/12KV 25A FC ÜLA 292/56	6/12	292 56	25 1	HH-SI 6/12KV 25A FC ÜLA 292/56	<b>67520-0250</b>
HH-SI 6/12KV 31,5A FC ÜLA 292/56	6/12	292 56	31,5 1	HH-SI 6/12KV 31,5A FC ÜLA 292/56	<b>67520-0320</b>
HH-SI 6/12KV 40A FC ÜLA 292/56	6/12	292 56	40 1	HH-SI 6/12KV 40A FC ÜLA 292/56	<b>67520-0400</b>
HH-SI 6/12KV 50A FC ÜLA 292/56	6/12	292 56	50 1	HH-SI 6/12KV 50A FC ÜLA 292/56	<b>67520-0500</b>
HH-SI 6/12KV 63A FC ÜLA 292/65	6/12	292 65	63 1	HH-SI 6/12KV 63A FC ÜLA 292/65	<b>67520-0630</b>
HH-SI 6/12KV 80A FC ÜLA 292/65	6/12	292 65	80 1	HH-SI 6/12KV 80A FC ÜLA 292/65	<b>67520-0800</b>
HH-SI 6/12KV 100A FC ÜLA 292/65	6/12	292 65	100 1	HH-SI 6/12KV 100A FC ÜLA 292/65	<b>67520-1000</b>
HH-SI 6/12KV 125A FC ÜLA 292/88	6/12	292 88	125 1	HH-SI 6/12KV 125A FC ÜLA 292/88	<b>67520-1250</b>
HH-SI 6/12KV 160A FC ÜLA 292/88	6/12	292 88	160 1	HH-SI 6/12KV 160A FC ÜLA 292/88	<b>67520-1600</b>
HH-SI 10/24KV 6,3A FC ÜLA 442/56	10/24	442 56	6,3 1	HH-SI 10/24KV 6,3A FC ÜLA 442/56	<b>67541-0060</b>
HH-SI 10/24KV 10A FC ÜLA 442/56	10/24	442 56	10 1	HH-SI 10/24KV 10A FC ÜLA 442/56	<b>67541-0100</b>
HH-SI 10/24KV 16A FC ÜLA 442/56	10/24	442 56	16 1	HH-SI 10/24KV 16A FC ÜLA 442/56	<b>67541-0160</b>
HH-SI 10/24KV 20A FC ÜLA 442/56	10/24	442 56	20 1	HH-SI 10/24KV 20A FC ÜLA 442/56	<b>67541-0200</b>
HH-SI 10/24KV 25A FC ÜLA 442/56	10/24	442 56	25 1	HH-SI 10/24KV 25A FC ÜLA 442/56	<b>67541-0250</b>
HH-SI 10/24KV 31,5A FC ÜLA 442/56	10/24	442 56	31,5 1	HH-SI 10/24KV 31,5A FC ÜLA 442/56	<b>67541-0320</b>
HH-SI 10/24KV 40A FC ÜLA 442/56	10/24	442 56	40 1	HH-SI 10/24KV 40A FC ÜLA 442/56	<b>67541-0400</b>
HH-SI 10/24KV 50A FC ÜLA 442/65	10/24	442 65	50 1	HH-SI 10/24KV 50A FC ÜLA 442/65	<b>67541-0500</b>
HH-SI 10/24KV 63A FC ÜLA 442/65	10/24	442 65	63 1	HH-SI 10/24KV 63A FC ÜLA 442/65	<b>67541-0630</b>
HH-SI 10/24KV 80A FC ÜLA 442/65	10/24	442 65	80 1	HH-SI 10/24KV 80A FC ÜLA 442/65	<b>67541-0800</b>
HH-SI 10/24KV 100A FC ÜLA 442/88	10/24	442 88	100 1	HH-SI 10/24KV 100A FC ÜLA 442/88	<b>67541-1000</b>
HH-SI 20/36KV 6,3A FC ÜLA 537/56	20/36	537 56	6,3 1	HH-SI 20/36KV 6,3A FC ÜLA 537/56	<b>67550-0060</b>
HH-SI 20/36KV 10A FC ÜLA 537/56	20/36	537 56	10 1	HH-SI 20/36KV 10A FC ÜLA 537/56	<b>67550-0100</b>
HH-SI 20/36KV 16A FC ÜLA 537/56	20/36	537 56	16 1	HH-SI 20/36KV 16A FC ÜLA 537/56	<b>67550-0160</b>
HH-SI 20/36KV 20A FC ÜLA 537/56	20/36	537 56	20 1	HH-SI 20/36KV 20A FC ÜLA 537/56	<b>67550-0200</b>
HH-SI 20/36KV 25A FC ÜLA 537/56	20/36	537 56	25 1	HH-SI 20/36KV 25A FC ÜLA 537/56	<b>67550-0250</b>
HH-SI 20/36KV 31,5A FC ÜLA 537/65	20/36	537 65	31,5 1	HH-SI 20/36KV 31,5A FC ÜLA 537/65	<b>67550-0320</b>
HH-SI 20/36KV 40A FC ÜLA 537/65	20/36	537 65	40 1	HH-SI 20/36KV 40A FC ÜLA 537/65	<b>67550-0400</b>
HH-SI 20/36KV 50A FC ÜLA 537/88	20/36	537 88	50 1	HH-SI 20/36KV 50A FC ÜLA 537/88	<b>67550-0500</b>
HH-SI 10/24KV 6,3A FC ÜLA+ 442/56 K44,8	10/24	442 56	6,3 1	HH-SI 10/24KV 6,3A FC ÜLA+ 442/56 K44,8	<b>67543-0060</b>
HH-SI 10/24KV 10A FC ÜLA+ 442/56 K44,8	10/24	442 56	10 1	HH-SI 10/24KV 10A FC ÜLA+ 442/56 K44,8	<b>67543-0100</b>
HH-SI 10/24KV 16A FC ÜLA+ 442/56 K44,8	10/24	442 56	16 1	HH-SI 10/24KV 16A FC ÜLA+ 442/56 K44,8	<b>67543-0160</b>
HH-SI 10/24KV 20A FC ÜLA+ 442/56 K44,8	10/24	442 56	20 1	HH-SI 10/24KV 20A FC ÜLA+ 442/56 K44,8	<b>67543-0200</b>
HH-SI 10/24KV 25A FC ÜLA+ 442/56 K44,8	10/24	442 56	25 1	HH-SI 10/24KV 25A FC ÜLA+ 442/56 K44,8	<b>67543-0250</b>
HH-SI 10/24KV 31,5A FC ÜLA+ 442/56 K44,8	10/24	442 56	31,5 1	HH-SI 10/24KV 31,5A FC ÜLA+ 442/56 K44,8	<b>67543-0320</b>
HH-SI 10/24KV 40A FC ÜLA+ 442/56 K44,8	10/24	442 56	40 1	HH-SI 10/24KV 40A FC ÜLA+ 442/56 K44,8	<b>67543-0400</b>
HH-SI 10/24KV 50A FC ÜLA+ 442/65 K44,8	10/24	442 65	50 1	HH-SI 10/24KV 50A FC ÜLA+ 442/65 K44,8	<b>67543-0500</b>
HH-SI 10/24KV 63A FC ÜLA+ 442/65 K44,8	10/24	442 65	63 1	HH-SI 10/24KV 63A FC ÜLA+ 442/65 K44,8	<b>67542-0630</b>
HH-SI 10/24KV 63A FC ÜLA+ 442/78 K44,8	10/24	442 78	63 1	HH-SI 10/24KV 63A FC ÜLA+ 442/78 K44,8	<b>67543-0630</b>
HH-SI 10/24KV 80A FC ÜLA+ 442/78 K44,8	10/24	442 78	80 1	HH-SI 10/24KV 80A FC ÜLA+ 442/78 K44,8	<b>67543-0800</b>
HH-SI 10/24KV 100A FC ÜLA+ 442/88 K44,8	10/24	442 88	100 1	HH-SI 10/24KV 100A FC ÜLA+ 442/88 K44,8	<b>67543-1000</b>
HH-SI 10/24KV 125A FC ÜLA+ 442/88 K44,8	10/24	442 88	125 1	HH-SI 10/24KV 125A FC ÜLA+ 442/88 K44,8	<b>67543-1250</b>



67520-0100

## HV Fuse-Links acc. to VDE 0670 T402 / IEC 60 282-1

► Technical data, page 90, 94



67543-0060

**HV back-up Fuse-Links acc. to VDE 0670 T402 / IEC 60282-1 with controlled power dissipation (ÜLA Plus)**

Designation	Rated volt. kV	Length Ø	Amps PU	Product designation	Order no.
HH-SI 10/24KV 6,3A FC ÜLA+ 442/56 K44,8	10/24	442 56	6,3 1	HH-SI 10/24KV 6,3A FC ÜLA+ 442/56 K44,8	<b>67543-0060</b>
HH-SI 10/24KV 10A FC ÜLA+ 442/56 K44,8	10/24	442 56	10 1	HH-SI 10/24KV 10A FC ÜLA+ 442/56 K44,8	<b>67543-0100</b>
HH-SI 10/24KV 16A FC ÜLA+ 442/56 K44,8	10/24	442 56	16 1	HH-SI 10/24KV 16A FC ÜLA+ 442/56 K44,8	<b>67543-0160</b>
HH-SI 10/24KV 20A FC ÜLA+ 442/56 K44,8	10/24	442 56	20 1	HH-SI 10/24KV 20A FC ÜLA+ 442/56 K44,8	<b>67543-0200</b>
HH-SI 10/24KV 25A FC ÜLA+ 442/56 K44,8	10/24	442 56	25 1	HH-SI 10/24KV 25A FC ÜLA+ 442/56 K44,8	<b>67543-0250</b>
HH-SI 10/24KV 31,5A FC ÜLA+ 442/56 K44,8	10/24	442 56	31,5 1	HH-SI 10/24KV 31,5A FC ÜLA+ 442/56 K44,8	<b>67543-0320</b>
HH-SI 10/24KV 40A FC ÜLA+ 442/56 K44,8	10/24	442 56	40 1	HH-SI 10/24KV 40A FC ÜLA+ 442/56 K44,8	<b>67543-0400</b>
HH-SI 10/24KV 50A FC ÜLA+ 442/65 K44,8	10/24	442 65	50 1	HH-SI 10/24KV 50A FC ÜLA+ 442/65 K44,8	<b>67543-0500</b>
HH-SI 10/24KV 63A FC ÜLA+ 442/65 K44,8	10/24	442 65	63 1	HH-SI 10/24KV 63A FC ÜLA+ 442/65 K44,8	<b>67542-0630</b>
HH-SI 10/24KV 63A FC ÜLA+ 442/78 K44,8	10/24	442 78	63 1	HH-SI 10/24KV 63A FC ÜLA+ 442/78 K44,8	<b>67543-0630</b>
HH-SI 10/24KV 80A FC ÜLA+ 442/78 K44,8	10/24	442 78	80 1	HH-SI 10/24KV 80A FC ÜLA+ 442/78 K44,8	<b>67543-0800</b>
HH-SI 10/24KV 100A FC ÜLA+ 442/88 K44,8	10/24	442 88	100 1	HH-SI 10/24KV 100A FC ÜLA+ 442/88 K44,8	<b>67543-1000</b>
HH-SI 10/24KV 125A FC ÜLA+ 442/88 K44,8	10/24	442 88	125 1	HH-SI 10/24KV 125A FC ÜLA+ 442/88 K44,8	<b>67543-1250</b>
HH-SI 20/36KV 6,3A FC ÜLA+ 537/56 K44,8	20/36	537 56	6,3 1	HH-SI 20/36KV 6,3A FC ÜLA+ 537/56 K44,8	<b>67553-0060</b>
HH-SI 20/36KV 10A FC ÜLA+ 537/56 K44,8	20/36	537 56	10 1	HH-SI 20/36KV 10A FC ÜLA+ 537/56 K44,8	<b>67553-0100</b>
HH-SI 20/36KV 16A FC ÜLA+ 537/56 K44,8	20/36	537 56	16 1	HH-SI 20/36KV 16A FC ÜLA+ 537/56 K44,8	<b>67553-0160</b>
HH-SI 20/36KV 20A FC ÜLA+ 537/56 K44,8	20/36	537 56	20 1	HH-SI 20/36KV 20A FC ÜLA+ 537/56 K44,8	<b>67553-0200</b>
HH-SI 20/36KV 25A FC ÜLA+ 537/56 K44,8	20/36	537 56	25 1	HH-SI 20/36KV 25A FC ÜLA+ 537/56 K44,8	<b>67553-0250</b>
HH-SI 20/36KV 31,5A FC ÜLA+ 537/65 K44,8	20/36	537 65	31,5 1	HH-SI 20/36KV 31,5A FC ÜLA+ 537/65 K44,8	<b>67553-0320</b>
HH-SI 20/36KV 40A FC ÜLA+ 537/65 K44,8	20/36	537 65	40 1	HH-SI 20/36KV 40A FC ÜLA+ 537/65 K44,8	<b>67553-0400</b>
HH-SI 20/36KV 50A FC ÜLA+ 537/88 K44,8	20/36	537 88	50 1	HH-SI 20/36KV 50A FC ÜLA+ 537/88 K44,8	<b>67553-0500</b>
HH-SI 20/36KV 63A FC ÜLA+ 537/88 K44,8	20/36	537 88	63 1	HH-SI 20/36KV 63A FC ÜLA+ 537/88 K44,8	<b>67553-0630</b>
HH-SI 20/36KV 80A FC ÜLA+ 537/88 K44,8	20/36	537 88	80 1	HH-SI 20/36KV 80A FC ÜLA+ 537/88 K44,8	<b>67553-0800</b>



67420-0060

**HV general-purpose Fuse-Links**

Designation	Rated volt. kV	Length Ø	Amps PU	Product designation	Order no.
HH-SI 6/12KV 6,3A FC VB 292/65	6/12	292 65	6,3 1	HH-SI 6/12KV 6,3A FC VB 292/65	<b>67420-0060</b>
HH-SI 6/12KV 16A FC VB 292/65	6/12	292 65	16 1	HH-SI 6/12KV 16A FC VB 292/65	<b>67420-0160</b>
HH-SI 6/12KV 25A FC VB 292/65	6/12	292 65	25 1	HH-SI 6/12KV 25A FC VB 292/65	<b>67420-0250</b>
HH-SI 6/12KV 40A FC VB 292/78	6/12	292 78	40 1	HH-SI 6/12KV 40A FC VB 292/78	<b>67420-0400</b>
HH-SI 6/12KV 50A FC VB 292/88	6/12	292 88	50 1	HH-SI 6/12KV 50A FC VB 292/88	<b>67420-0500</b>
HH-SI 10/24KV 4A FC VB 442/78	10/24	442 78	4,0 1	HH-SI 10/24KV 4A FC VB 442/78	<b>67440-0040</b>
HH-SI 10/24KV 6,3A FC VB 442/78	10/24	442 78	6,3 1	HH-SI 10/24KV 6,3A FC VB 442/78	<b>67440-0060</b>
HH-SI 10/24KV 10A FC VB 442/78	10/24	442 78	10 1	HH-SI 10/24KV 10A FC VB 442/78	<b>67440-0100</b>
HH-SI 10/24KV 16A FC VB 442/78	10/24	442 78	16 1	HH-SI 10/24KV 16A FC VB 442/78	<b>67440-0160</b>
HH-SI 10/24KV 25A FC VB 442/88	10/24	442 88	25 1	HH-SI 10/24KV 25A FC VB 442/88	<b>67440-0250</b>

# HV Fuse-Links acc. to VDE 0670 T4 / IEC 60 282-1

► Technical data, page 102



67220-0400

## HV back-up Fuse-Links acc. to VDE 0670 T4 / IEC 60 282-1

Designation	Rated volt. kV	Length	Ø	Amps	PU	Product designation	Order no.
HH-SI 3/7,2KV 2A FC TB 192/56	3/7,2	192	56	2	1	HH-SI 3/7,2KV 2A FC TB 192/56	<b>67210-0020</b>
HH-SI 3/7,2KV 4A FC TB 192/56	3/7,2	192	56	4	1	HH-SI 3/7,2KV 4A FC TB 192/56	<b>67210-0040</b>
HH-SI 3/7,2KV 63A FC TB 192/65	3/7,2	192	65	63	1	HH-SI 3/7,2KV 63A FC TB 192/65	<b>67210-0630</b>
HH-SI 3/7,2KV 80A FC TB 192/65	3/7,2	192	65	80	1	HH-SI 3/7,2KV 80A FC TB 192/65	<b>67210-0800</b>
HH-SI 3/7,2KV 100A FC TB 192/65	3/7,2	192	65	100	1	HH-SI 3/7,2KV 100A FC TB 192/65	<b>67210-1000</b>
HH-SI 3/7,2KV 160A FC TB 192/88	3/7,2	192	88	160	1	HH-SI 3/7,2KV 160A FC TB 192/88	<b>67210-1600</b>
HH-SI 3/7,2KV 200A FC TB 192/88	3/7,2	192	88	200	1	HH-SI 3/7,2KV 200A FC TB 192/88	<b>67210-2000</b>
HH-SI 6/12KV 1A FC TB 292/56	6/12	292	56	1	1	HH-SI 6/12KV 1A FC TB 292/56	<b>67220-0010</b>
HH-SI 6/12KV 2A FC TB 292/56	6/12	292	56	2	1	HH-SI 6/12KV 2A FC TB 292/56	<b>67220-0020</b>
HH-SI 6/12KV 4A FC TB 292/56	6/12	292	56	4	1	HH-SI 6/12KV 4A FC TB 292/56	<b>67220-0040</b>
HH-SI 6/12KV 6,3A FC TB 292/56	6/12	292	56	6,3	1	HH-SI 6/12KV 6,3A FC TB 292/56	<b>67220-0060</b>
HH-SI 6/12KV 10A FC TB 292/56	6/12	292	56	10	1	HH-SI 6/12KV 10A FC TB 292/56	<b>67220-0100</b>
HH-SI 6/12KV 16A FC TB 292/56	6/12	292	56	16	1	HH-SI 6/12KV 16A FC TB 292/56	<b>67220-0160</b>
HH-SI 6/12KV 20A FC TB 292/56	6/12	292	56	20	1	HH-SI 6/12KV 20A FC TB 292/56	<b>67220-0200</b>
HH-SI 6/12KV 25A FC TB 292/56	6/12	292	56	25	1	HH-SI 6/12KV 25A FC TB 292/56	<b>67220-0250</b>
HH-SI 6/12KV 31,5A FC TB 292/56	6/12	292	56	31,5	1	HH-SI 6/12KV 31,5A FC TB 292/56	<b>67220-0320</b>
HH-SI 6/12KV 40A FC TB 292/56	6/12	292	56	40	1	HH-SI 6/12KV 40A FC TB 292/56	<b>67220-0400</b>
HH-SI 6/12KV 50A FC TB 292/56	6/12	292	56	50	1	HH-SI 6/12KV 50A FC TB 292/56	<b>67220-0500</b>
HH-SI 6/12KV 63A FC TB 292/56	6/12	292	56	63	1	HH-SI 6/12KV 63A FC TB 292/56	<b>67220-0630</b>
HH-SI 6/12KV 80A FC TB 292/65	6/12	292	65	80	1	HH-SI 6/12KV 80A FC TB 292/65	<b>67220-0800</b>
HH-SI 6/12KV 100A FC TB 292/65	6/12	292	65	100	1	HH-SI 6/12KV 100A FC TB 292/65	<b>67220-1000</b>
HH-SI 6/12KV 125A FC TB 292/88	6/12	292	88	125	1	HH-SI 6/12KV 125A FC TB 292/88	<b>67220-1250</b>
HH-SI 6/12KV 160A FC TB 292/88	6/12	292	88	160	1	HH-SI 6/12KV 160A FC TB 292/88	<b>67220-1600</b>
HH-SI 6/12KV 200A FC TB 292/88	6/12	292	88	200	1	HH-SI 6/12KV 200A FC TB 292/88	<b>67220-2000</b>
HH-SI 6/12KV 250A FC TB 292/88	6/12	292	88	250	1	HH-SI 6/12KV 250A FC TB 292/88	<b>67220-2500</b>
HH-SI 10/17,5KV 2A FC TB 367/56	10/17,5	367	56	2	1	HH-SI 10/17,5KV 2A FC TB 367/56	<b>67230-0020</b>
HH-SI 10/17,5KV 4A FC TB 367/56	10/17,5	367	56	4	1	HH-SI 10/17,5KV 4A FC TB 367/56	<b>67230-0040</b>
HH-SI 10/17,5KV 50A FC TB 367/65	10/17,5	367	65	50	1	HH-SI 10/17,5KV 50A FC TB 367/65	<b>67230-0500</b>
HH-SI 10/17,5KV 63A FC TB 367/65	10/17,5	367	65	63	1	HH-SI 10/17,5KV 63A FC TB 367/65	<b>67230-0630</b>
HH-SI 10/17,5KV 80A FC TB 367/65	10/17,5	367	65	80	1	HH-SI 10/17,5KV 80A FC TB 367/65	<b>67230-0800</b>
HH-SI 10/17,5KV 100A FC TB 367/65	10/17,5	367	65	100	1	HH-SI 10/17,5KV 100A FC TB 367/65	<b>67230-1000</b>
HH-SI 10/24KV 1A FC TB 442/56	10/24	442	56	1	1	HH-SI 10/24KV 1A FC TB 442/56	<b>67240-0010</b>
HH-SI 10/24KV 2A FC TB 442/56	10/24	442	56	2	1	HH-SI 10/24KV 2A FC TB 442/56	<b>67240-0020</b>
HH-SI 10/24KV 4A FC TB 442/56	10/24	442	56	4	1	HH-SI 10/24KV 4A FC TB 442/56	<b>67240-0040</b>
HH-SI 10/24KV 6,3A FC TB 442/56	10/24	442	56	6,3	1	HH-SI 10/24KV 6,3A FC TB 442/56	<b>67240-0060</b>
HH-SI 10/24KV 10A FC TB 442/56	10/24	442	56	10	1	HH-SI 10/24KV 10A FC TB 442/56	<b>67240-0100</b>
HH-SI 10/24KV 16A FC TB 442/56	10/24	442	56	16	1	HH-SI 10/24KV 16A FC TB 442/56	<b>67240-0160</b>
HH-SI 10/24KV 20A FC TB 442/56	10/24	442	56	20	1	HH-SI 10/24KV 20A FC TB 442/56	<b>67240-0200</b>
HH-SI 10/24KV 25A FC TB 442/56	10/24	442	56	25	1	HH-SI 10/24KV 25A FC TB 442/56	<b>67240-0250</b>
HH-SI 10/24KV 31,5A FC TB 442/56	10/24	442	56	31,5	1	HH-SI 10/24KV 31,5A FC TB 442/56	<b>67240-0320</b>
HH-SI 10/24KV 40A FC TB 442/56	10/24	442	56	40	1	HH-SI 10/24KV 40A FC TB 442/56	<b>67240-0400</b>
HH-SI 10/24KV 50A FC TB 442/56	10/24	442	56	50	1	HH-SI 10/24KV 50A FC TB 442/56	<b>67240-0500</b>
HH-SI 10/24KV 63A FC TB 442/65	10/24	442	65	63	1	HH-SI 10/24KV 63A FC TB 442/65	<b>67240-0630</b>
HH-SI 10/24KV 80A FC TB 442/65	10/24	442	65	80	1	HH-SI 10/24KV 80A FC TB 442/65	<b>67240-0800</b>
HH-SI 10/24KV 100A FC TB 442/78	10/24	442	78	100	1	HH-SI 10/24KV 100A FC TB 442/78	<b>67240-1000</b>
HH-SI 10/24KV 125A FC TB 442/88	10/24	442	88	125	1	HH-SI 10/24KV 125A FC TB 442/88	<b>67240-1250</b>
HH-SI 10/24KV 160A FC TB 442/88	10/24	442	88	160	1	HH-SI 10/24KV 160A FC TB 442/88	<b>67240-1600</b>
HH-SI 20/36KV 2A FC TB 537/56	20/36	537	56	2	1	HH-SI 20/36KV 2A FC TB 537/56	<b>67250-0020</b>
HH-SI 20/36KV 4A FC TB 537/56	20/36	537	56	4	1	HH-SI 20/36KV 4A FC TB 537/56	<b>67250-0040</b>
HH-SI 20/36KV 6,3A FC TA 537/56	20/36	537	56	6,3	1	HH-SI 20/36KV 6,3A FC TA 537/56	<b>67150-0060</b>
HH-SI 20/36KV 10A FC TA 537/56	20/36	537	56	10	1	HH-SI 20/36KV 10A FC TA 537/56	<b>67150-0100</b>
HH-SI 20/36KV 16A FC TA 537/56	20/36	537	56	16	1	HH-SI 20/36KV 16A FC TA 537/56	<b>67150-0160</b>
HH-SI 20/36KV 20A FC TA 537/56	20/36	537	56	20	1	HH-SI 20/36KV 20A FC TA 537/56	<b>67150-0200</b>
HH-SI 20/36KV 25A FC TA 537/56	20/36	537	56	25	1	HH-SI 20/36KV 25A FC TA 537/56	<b>67150-0250</b>
HH-SI 20/36KV 31,5A FC TA 537/65	20/36	537	65	31,5	1	HH-SI 20/36KV 31,5A FC TA 537/65	<b>67150-0320</b>
HH-SI 20/36KV 40A FC TA 537/65	20/36	537	65	40	1	HH-SI 20/36KV 40A FC TA 537/65	<b>67150-0400</b>
HH-SI 20/36KV 50A FC TA 537/88	20/36	537	88	50	1	HH-SI 20/36KV 50A FC TA 537/88	<b>67150-0500</b>
HH-SI 20/36KV 63A FC TA 537/88	20/36	537	88	63	1	HH-SI 20/36KV 63A FC TA 537/88	<b>67150-0630</b>

## HV Fuse-Links acc. to VDE 0670 T4 / IEC 60 282-1

► Technical data, page 102



67520-0100

### HV back-up Fuse-Links acc. to VDE 0670 T4 / IEC 60 282-1 with controlled power dissipation (ÜLA)

Designation	Rated volt. kV	Length	Ø	Amps	PU	Product designation	Order no.
HH-SI 6/12KV 1A FC TB ÜLA 292/56	6/12	292	56	1	1	HH-SI 6/12KV 1A FC TB ÜLA 292/56	<b>67220-0019</b>
HH-SI 6/12KV 2A FC TB ÜLA 292/56	6/12	292	56	2	1	HH-SI 6/12KV 2A FC TB ÜLA 292/56	<b>67220-0029</b>
HH-SI 6/12KV 4A FC TB ÜLA 292/56	6/12	292	56	4	1	HH-SI 6/12KV 4A FC TB ÜLA 292/56	<b>67220-0049</b>
HH-SI 6/12KV 6,3A FC TB ÜLA 292/56	6/12	292	56	6,3	1	HH-SI 6/12KV 6,3A FC TB ÜLA 292/56	<b>67220-0069</b>
HH-SI 6/12KV 10A FC TB ÜLA 292/56	6/12	292	56	10	1	HH-SI 6/12KV 10A FC TB ÜLA 292/56	<b>67220-0109</b>
HH-SI 6/12KV 16A FC TB ÜLA 292/56	6/12	292	56	16	1	HH-SI 6/12KV 16A FC TB ÜLA 292/56	<b>67220-0169</b>
HH-SI 6/12KV 20A FC TB ÜLA 292/56	6/12	292	56	20	1	HH-SI 6/12KV 20A FC TB ÜLA 292/56	<b>67220-0209</b>
HH-SI 6/12KV 25A FC TB ÜLA 292/56	6/12	292	56	25	1	HH-SI 6/12KV 25A FC TB ÜLA 292/56	<b>67220-0259</b>
HH-SI 6/12KV 31,5A FC TB ÜLA 292/56	6/12	292	56	31,5	1	HH-SI 6/12KV 31,5A FC TB ÜLA 292/56	<b>67220-0329</b>
HH-SI 6/12KV 40A FC TB ÜLA 292/56	6/12	292	56	40	1	HH-SI 6/12KV 40A FC TB ÜLA 292/56	<b>67220-0409</b>
HH-SI 6/12KV 50A FC TB ÜLA 292/56	6/12	292	56	50	1	HH-SI 6/12KV 50A FC TB ÜLA 292/56	<b>67220-0509</b>
HH-SI 6/12KV 63A FC TB ÜLA 292/56	6/12	292	56	63	1	HH-SI 6/12KV 63A FC TB ÜLA 292/56	<b>67220-0639</b>
HH-SI 6/12KV 80A FC TB ÜLA 292/65	6/12	292	65	80	1	HH-SI 6/12KV 80A FC TB ÜLA 292/65	<b>67220-0809</b>
HH-SI 6/12KV 100A FC TB ÜLA 292/65	6/12	292	65	100	1	HH-SI 6/12KV 100A FC TB ÜLA 292/65	<b>67220-1009</b>
HH-SI 6/12KV 125A FC TB ÜLA 292/88	6/12	292	88	125	1	HH-SI 6/12KV 125A FC TB ÜLA 292/88	<b>67220-1259</b>
HH-SI 6/12KV 160A FC TB ÜLA 292/88	6/12	292	88	160	1	HH-SI 6/12KV 160A FC TB ÜLA 292/88	<b>67220-1609</b>
HH-SI 6/12KV 200A FC TB ÜLA 292/88	6/12	292	88	200	1	HH-SI 6/12KV 200A FC TB ÜLA 292/88	<b>67220-2009</b>
HH-SI 10/24KV 1A FC TB ÜLA 442/56	10/24	442	56	1	1	HH-SI 10/24KV 1A FC TB ÜLA 442/56	<b>67240-0019</b>
HH-SI 10/24KV 2A FC TB ÜLA 442/56	10/24	442	56	2	1	HH-SI 10/24KV 2A FC TB ÜLA 442/56	<b>67240-0029</b>
HH-SI 10/24KV 4A FC TB ÜLA 442/56	10/24	442	56	4	1	HH-SI 10/24KV 4A FC TB ÜLA 442/56	<b>67240-0049</b>
HH-SI 10/24KV 6,3A FC TB ÜLA 442/56	10/24	442	56	6,3	1	HH-SI 10/24KV 6,3A FC TB ÜLA 442/56	<b>67240-0069</b>
HH-SI 10/24KV 10A FC TB ÜLA 442/56	10/24	442	56	10	1	HH-SI 10/24KV 10A FC TB ÜLA 442/56	<b>67240-0109</b>
HH-SI 10/24KV 16A FC TB ÜLA 442/56	10/24	442	56	16	1	HH-SI 10/24KV 16A FC TB ÜLA 442/56	<b>67240-0169</b>
HH-SI 10/24KV 20A FC TB ÜLA 442/56	10/24	442	56	20	1	HH-SI 10/24KV 20A FC TB ÜLA 442/56	<b>67240-0209</b>
HH-SI 10/24KV 25A FC TB ÜLA 442/56	10/24	442	56	25	1	HH-SI 10/24KV 25A FC TB ÜLA 442/56	<b>67240-0259</b>
HH-SI 10/24KV 31,5A FC TB ÜLA 442/56	10/24	442	56	31,5	1	HH-SI 10/24KV 31,5A FC TB ÜLA 442/56	<b>67240-0329</b>
HH-SI 10/24KV 40A FC TB ÜLA 442/56	10/24	442	56	40	1	HH-SI 10/24KV 40A FC TB ÜLA 442/56	<b>67240-0409</b>
HH-SI 10/24KV 50A FC TB ÜLA 442/56	10/24	442	56	50	1	HH-SI 10/24KV 50A FC TB ÜLA 442/56	<b>67240-0509</b>
HH-SI 10/24KV 63A FC TB ÜLA 442/65	10/24	442	65	63	1	HH-SI 10/24KV 63A FC TB ÜLA 442/65	<b>67240-0639</b>
HH-SI 10/24KV 80A FC TB ÜLA 442/65	10/24	442	65	80	1	HH-SI 10/24KV 80A FC TB ÜLA 442/65	<b>67240-0809</b>
HH-SI 10/24KV 100A FC TB ÜLA 442/78	10/24	442	78	100	1	HH-SI 10/24KV 100A FC TB ÜLA 442/78	<b>67240-1009</b>

# HV Fuse-Links acc. to VDE 0670 T4 / IEC 60 282-1

► Technical data, page 104



67004-0100

## HV back-up Fuse-Links 6/12 kV with a length "e" of 442 mm (24-kV tube)

Designation	Rated volt. kV	Length Ø	Amps PU	Product designation	Order no.
HH-SI 6/12KV 1A FC TB 442/56	6/12	442 56 1 1	1	HH-SI 6/12KV 1A FC TB 442/56	<b>67004-0010</b>
HH-SI 6/12KV 2A FC TB 442/56	6/12	442 56 2 1	1	HH-SI 6/12KV 2A FC TB 442/56	<b>67004-0020</b>
HH-SI 6/12KV 4A FC TB 442/56	6/12	442 56 4 1	1	HH-SI 6/12KV 4A FC TB 442/56	<b>67004-0040</b>
HH-SI 6/12KV 6,3A FC TB 442/56	6/12	442 56 6,3 1	1	HH-SI 6/12KV 6,3A FC TB 442/56	<b>67004-0060</b>
HH-SI 6/12KV 10A FC TB 442/56	6/12	442 56 10 1	1	HH-SI 6/12KV 10A FC TB 442/56	<b>67004-0100</b>
HH-SI 6/12KV 16A FC TB 442/56	6/12	442 56 16 1	1	HH-SI 6/12KV 16A FC TB 442/56	<b>67004-0160</b>
HH-SI 6/12KV 20A FC TB 442/56	6/12	442 56 20 1	1	HH-SI 6/12KV 20A FC TB 442/56	<b>67004-0200</b>
HH-SI 6/12KV 25A FC TB 442/56	6/12	442 56 25 1	1	HH-SI 6/12KV 25A FC TB 442/56	<b>67004-0250</b>
HH-SI 6/12KV 31,5A FC TB 442/56	6/12	442 56 31,5 1	1	HH-SI 6/12KV 31,5A FC TB 442/56	<b>67004-0320</b>
HH-SI 6/12KV 40A FC TB 442/56	6/12	442 56 40 1	1	HH-SI 6/12KV 40A FC TB 442/56	<b>67004-0400</b>
HH-SI 6/12KV 50A FC TB 442/56	6/12	442 56 50 1	1	HH-SI 6/12KV 50A FC TB 442/56	<b>67004-0500</b>
HH-SI 6/12KV 63A FC TB 442/56	6/12	442 56 63 1	1	HH-SI 6/12KV 63A FC TB 442/56	<b>67004-0630</b>
HH-SI 6/12KV 80A FC TB 442/65	6/12	442 65 80 1	1	HH-SI 6/12KV 80A FC TB 442/65	<b>67004-0800</b>
HH-SI 6/12KV 100A FC TB 442/65	6/12	442 65 100 1	1	HH-SI 6/12KV 100A FC TB 442/65	<b>67004-1000</b>
HH-SI 6/12KV 125A FC TB 442/88	6/12	442 88 125 1	1	HH-SI 6/12KV 125A FC TB 442/88	<b>67004-1250</b>
HH-SI 6/12KV 160A FC TB 442/88	6/12	442 88 160 1	1	HH-SI 6/12KV 160A FC TB 442/88	<b>67004-1600</b>
HH-SI 6/12KV 200A FC TB 442/88	6/12	442 88 200 1	1	HH-SI 6/12KV 200A FC TB 442/88	<b>67004-2000</b>



67004-0019

## HV back-up Fuse-Links 6/12 kV with a length "e" of 442 mm (24-kV tube) with controlled power dissipation (ÜLA)

Designation	Rated volt. kV	Length Ø	Amps PU	Product designation	Order no.
HH-SI 6/12KV 10A FC TB 442/56 ÜLA	6/12	442 56 10 1	1	HH-SI 6/12KV 10A FC TB 442/56 ÜLA	<b>67004-0109</b>
HH-SI 6/12KV 20A FC TB 442/56 ÜLA	6/12	442 56 20 1	1	HH-SI 6/12KV 20A FC TB 442/56 ÜLA	<b>67004-0209</b>
HH-SI 6/12KV 16A FC TB 442/56 ÜLA	6/12	442 56 16 1	1	HH-SI 6/12KV 16A FC TB 442/56 ÜLA	<b>67004-0169</b>
HH-SI 6/12KV 31,5A FC TB 442/56 ÜLA	6/12	442 56 31,5 1	1	HH-SI 6/12KV 16A FC TB 442/56 ÜLA	<b>67004-0329</b>
HH-SI 6/12KV 25A FC TB 442/56 ÜLA	6/12	442 56 25 1	1	HH-SI 6/12KV 25A FC TB 442/56 ÜLA	<b>67004-0259</b>
HH-SI 6/12KV 40A FC TB 442/56 ÜLA	6/12	442 56 40 1	1	HH-SI 6/12KV 40A FC TB 442/56 ÜLA	<b>67004-0409</b>
HH-SI 6/12KV 50A FC TB 442/56 ÜLA	6/12	442 56 50 1	1	HH-SI 6/12KV 50A FC TB 442/56 ÜLA	<b>67004-0509</b>
HH-SI 6/12KV 63A FC TB 442/56 ÜLA	6/12	442 56 63 1	1	HH-SI 6/12KV 63A FC TB 442/56 ÜLA	<b>67004-0639</b>
HH-SI 6/12KV 80A FC TB 442/65 ÜLA	6/12	442 65 80 1	1	HH-SI 6/12KV 80A FC TB 442/65 ÜLA	<b>67004-0809</b>
HH-SI 6/12KV 100A FC TB 442/65 ÜLA	6/12	442 65 100 1	1	HH-SI 6/12KV 100A FC TB 442/65 ÜLA	<b>67004-1009</b>
HH-SI 6/12KV 125A FC TB 442/88 ÜLA	6/12	442 88 125 1	1	HH-SI 6/12KV 125A FC TB 442/88 ÜLA	<b>67004-1259</b>
HH-SI 6/12KV 160A FC TB 442/88 ÜLA	6/12	442 88 160 1	1	HH-SI 6/12KV 160A FC TB 442/88 ÜLA	<b>67004-1609</b>

## Test devices and HV Fuse-Links for voltage transformers

► Technical data, page 92, 107



68013-0020

### Test device for tripping medium voltage switches

Designation	Rated volt. kV	Length Ø	Amps PU	Product designation	Order no.
Test device 192 mm, 65 Nm	7,2	192	1	PRÜFSICHERUNG 65N e/D = 192mm	<b>68013-0020</b>
Extension to 292 mm	12	292	1	VERLÄNGER. F. PRÜFSICHERUNG 12KV e/D=292	<b>68014-0010</b>
Extension to 442 mm	24	442	1	VERLÄNGER. F. PRÜFSICHERUNG 24KV e/D=442	<b>68015-0010</b>



67036-0003

### High-voltage Fuse-Links for high-voltage transformer "HSW" acc. to VDE 0670 T4 / IEC 60 282-1

Designation	Rated volt. kV	Length Ø	Amps PU	Product designation	Order no.
Without indicator	6/12	160	22 1,25 1	HSW 6/12KV OHNE ANZEIGER	<b>67036-0003</b>
Without indicator	15/24	280	22 1,25 1	HSW 15/24KV OHNE ANZEIGER	<b>67037-0003</b>
Without indicator	20/36	421	37 1,00 1	HSW 20/36KV OHNE ANZEIGER	<b>67088-0003</b>
With indicator	6/12	160	22 1,6 1	HSW 6/12KV	<b>67036-0004</b>
With indicator	15/24	280	22 1,4 1	HSW 15/24KV	<b>67037-0004</b>

## Accessories for HV Fuse-Links

► Technical data, page 106



68007-0010

### HV fuse base acc. to DIN 43 624 for indoor use

Designation	Rated volt. kV	Length	Ø	Amps	PU	Product designation	Order no.
Fuse base	12	293	45	1		HH-SICHERUNGSTRÄGER 12KV INNENRAUM BZM	<b>68007-0010</b>
Fuse base	24	443	45	1		HH-SICHERUNGSTRÄGER 24KV INNENRAUM BZM	<b>68008-0010</b>
Fuse base	36	538	45	1		HH-SICHERUNGSTRÄGER 36KV INNENRAUM BZM	<b>68012-0010</b>
Fuse base	7,2	193	45	1		HH-SICHERUNGSTRÄGER 7,2KV INNENRAUM BZM	<b>68021-0010</b>



68016-0010

### Fuse base contacts, 200 A rated current, for indoor use

Designation	Amps	PU	Product designation	Order no.
Fuse base contacts	200	1	RUNDKONTAKT NBF MIT ANSCHLUSSMATERIAL	<b>68016-0010</b>
Fuse base contact with anti-vibration bracket	200	1	Rundkontakt mit Bügel für Rüttelsicherheit	<b>68005-0010</b>

### Fuse base contacts, 200 A rated current, for outdoor use

Designation	Amps	PU	Product designation	Order no.
Fuse base contacts	200	1	RUNDKONTAKT FREILUFT	<b>81931-0100</b>

### HSW-fuse holder

Designation	PU	Product designation	Order no.
HSW FUSE HOLDER	1	HSW-SICHERUNGSHALTER / FUSE HOLDER	<b>68022-0010</b>



67033-0003

### HV solid links

Designation	Rated volt. kV	Length	Ø	Amps	PU	Product designation	Order no.
Solid link 292/51	12	292	51	1		DURCHSCHALTEINSATZ 12KV 292/51	<b>67033-0003</b>
Solid link 442/51	24	442	51	1		DURCHSCHALTEINSATZ 24KV 442/51	<b>67034-0003</b>



68003-0100

### Adapter for high-voltage Fuse-Links acc. to DIN 43 625

#### Features:

- For use of 292-mm (12-kV) fuse-links in 442-mm (24-kV) systems
- For HV fuse-links with grooved cap only

Designation	Ø	Amps	PU	Product designation	Order no.
Adapter	45	200	1	ADAPTER FÜR HH-SI IN SENKR. MONTAGE	<b>68003-0100</b>
Adapter HV-SI 44.8			1	Adapter HH-SI 44,8	<b>68003-0200</b>



68004-0010

### Wall rack

#### Features:

- Holds 3 HV fuse-links

Designation	Amps	PU	Product designation	Order no.
Wall rack		2	WANDHALTERUNG FÜR HH-SICHERUNGEN	<b>68004-0010</b>

# HV Fuse-Links

## General remarks

### General information

HV fuse-links have been ensuring reliable protection in medium-voltage substations and grids for decades. They protect systems and equipment against the thermal and dynamic effects of short-circuits.

EFEN HV fuse-links provide the following significant features:

- High breaking capacity
- High current limitation
- Low switching voltage
- Quick breaking
- Non-ageing

EFEN HV fuse-links comply with the following standards:

- VDE 0670 T4 / IEC 60 282-1: High-voltage "current-limiting fuses"
- VDE 0670 T402: Selection of current-limiting fuses for transformer circuits
- IEC 60 787: Application guide for the selection of fuse-links of high-voltage fuses for transformer circuit applications
- VDE 0671 T105 / IEC 62271-105: High-voltage switch-fuse combinations
- DIN 43 625: High-voltage fuses, rated voltages 3.6 to 36 kV (fuse-link dimensions)
- DIN 43 624: High-voltage fuses, rated voltages 3/3.6 to 30/36 kV (single-pole fuse bases)

The quality management system of EFEN GmbH is certified to the international standard DIN ISO 9001 (EN 29001).

EFEN applies a certified environment management system acc. to DIN ISO 14001 and the Eco Audit Order of the Council (EEC) 1836/93.

EFEN manufactures HV fuse-links dimensioned acc. to DIN 43 625 with strikers for indoor and outdoor use. Due to its red color, the striker can be used as a trip-free mechanism and also as an indicator.

In addition to the HV fuse-links shown in this catalogue, EFEN also manufactures a wide range of special-purpose fuse-links in other or custom dimensions. If you have a particular application that requires a special fuse protection solution, simply ask the EFEN team, we are there for you!

### Terms and definitions

According to the applicable standards and physical properties, distinction is made between back-up fuse-links and general-purpose fuse-links:

### Back-up Fuse-Links

Back-up fuse-links have a "rated minimum breaking current" from which the fuse-links are able to interrupt current. Back-up fuse-links cannot interrupt current when operated below their "rated minimum breaking current" (below  $I_3$ ). They operate from  $I_3$  to the "rated maximum breaking current" ( $I_1$ ).

When assigning back-up fuse-links, it must be considered that the lowest short-circuit current at the point of installation of the HV back-up fuse-link is higher than  $I_3$  ( $I_{kmin} > I_3$ ). If the short-circuit current is possibly lower than the minimum breaking current, additional protection must be provided.

### General-purpose Fuse-Links

EFEN's general-purpose fuse-links comply with the correspondingly defined standards. Their operating range is extended for lower currents. These fuse-links are capable of interrupting all currents from any current causing the fuse-link to melt within a period of at least 1 hour and up to the "maximum rated breaking current" ( $I_1$ ). This allows these fuse-links to interrupt low fault currents reliably.

### Striker

The strikers of the HV fuse-links of this product list have an effective length of 30 mm and are of type "medium". This classification results from the energy released by the striker between the points A and B (Fig.1). The initial force is approx. 80 N, the force at the end of the free motion is approx. 15 N. The striker is provided to serve as trip-free mechanism of the load-break switches.

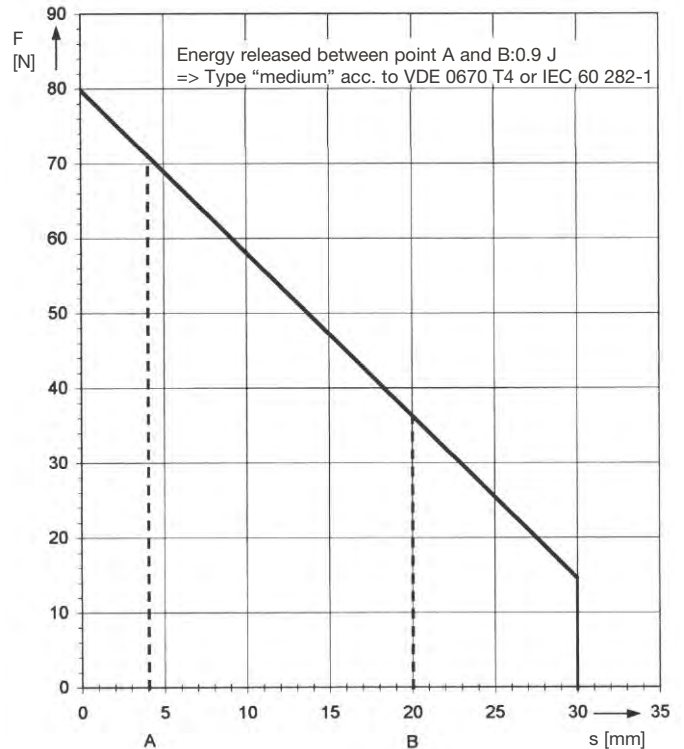

Fig.1

## HV Fuse-Links

### General remarks

#### Rated voltage range

When selecting HV fuse-links, it is important to ensure that these are operated at the voltage for which they are rated. Accordingly, the operating voltage must correspond to the maximum rated voltage of the fuse-link. Because of the switching voltage occurring during arcing, the fuse-link cannot be used at lower voltages without limitation. Accordingly, a lower operating voltage must also be observed at which the fuse-link can still be used without exceeding the system insulation level during arcing.

These two values define the fuse-link's permissible voltage range indicated on the fuse-link or in the technical data, e.g. 10/24 kV.

#### Breaking capacity $I_1$

The breaking capacity is also referred to as "rated maximum breaking current". This clearly indicates that this is the maximum current that the fuse-link is able to interrupt.

$I_1$  of the fuse-link must be greater than the maximum short-circuit current at the fuse-link's point of installation ( $I_1 > I_{Kmax}$ ).

#### Minimum breaking current $I_3$

According to the standard, the minimum breaking current is referred to as "rated minimum breaking current". This value must be specified on backup fuse-links. This is the minimum current from which on back-up fuse-links are capable of breaking fault currents.

Fuse-links must be assigned to systems in such a way that no fault current below  $I_3$  can occur at the fuse-link's point of installation (because of the system parameters or other protective devices).

#### Power dissipation of a fuse-link $P_{warm}$

The power dissipation of an HV fuse-link is specified at the fuse-link's rated current. When protecting systems with HV fuse-links, it must be noted that the operating current is normally no more than half the rated current. Due to the physical correlations, the actual power dissipation is less than a quarter of the value  $P_{warm}$  shown in the technical data table for HV fuse-links.

#### Time-current characteristic (I/t characteristic)

The time-current characteristics show the correlation between the current and pre-arcing time required for the fuse-element to melt. This is indicated as the virtual time ( $t_{vs}$ ) to allow comparing the I/t characteristics of fuse-links in the range below 100 ms. For coordination with other protective devices such as load-break switches or circuit breakers tripping at less than 100 ms the pre-arcing interval of  $I^2t$  must be applied.

#### Current limitation

At high short-circuit currents, HV fuse-links interrupt currents within few milliseconds. This means that the sinusoidal current does not reach its peak value and the HV fuse-links act as current-limiting devices. This is a significant advantage compared to mechanical switches whose contacts take longer to open and interrupt currents at natural zero. During this period, the peak short-circuit current is able to freely develop its dynamic force. By using HV fuse-links, this surge current is limited within several ms to a fraction of its peak value, allowing the design of the downstream system to be reduced in terms of dynamic forces.

#### Switching voltage

To allow HV fuse-links to perform as current-limiters, the short-circuit current must be limited and reduced already as it increases. This requires a switching voltage that counteracts the driving system voltage and forces the current to zero. According to the specifications stated above, this switching voltage must not exceed the permissible value of 2.2 times the peak value of the maximum rated voltage. EFEN HV fuse-links meet this requirement.

#### Dimensions

HV fuse-links in this product list comply with DIN 43 625.

Fig. 2 shows the contact cap dimensions defined in this standard. Dimension "e" varies depending on the rated voltage of HV fuse-links and is shown as "dimension" of the fuse-links in the corresponding technical data tables. In addition, diameter "d" varies with the rated current. The corresponding values are also shown in the tables.

(Tables on page 90, 98, 101, 102 and 103)

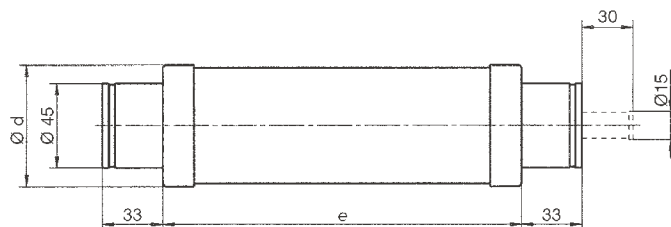

Fig. 2  
Dimensions acc. to DIN 43 625 in mm

## HV Fuse-Links

### General remarks

---

#### Description of further applications of EFEN HV Fuse-Links

##### Protection of high-voltage motors

With EFEN HV back-up fuse-links, high-voltage squirrel-cage motors can be protected against the effects of high short-circuit currents. Overloads must be interrupted by accompanying protective devices.

##### Protection of high-voltage capacitors

EFEN HV back-up fuse-links can be used to protect individual capacitors in the event of a short-circuit. However, particular aspects must be taken into account with respect to the rated voltage and rated current of the HV fuse-links.

##### Protection against distance short-circuits

HV fuse-links are not always used on bus bars or directly at the feeder, but rather directly upstream of the transformer at the end of a stub line. In such cases, it should be noted that the short-circuit current at the installation point of the HV fuse-links can be considerably lower than the current on a transformer secondary terminal short-circuit. In addition to transformer impedance, line impedance must also be taken into account.

##### Special applications

In addition to the standard applications described above, EFEN HV fuse-links can also be used for a wide range of special-purpose applications:

- Protection of voltage transformers
- Protection of capacitive transformers
- Protection of railway installations (16 2/3 Hz or DC)

##### Oil-tight HV Fuse-Links

EFEN also manufactures oil-tight HV fuse-links.

These fuse-links can be directly integrated into the devices to be protected such as transformer as they are suitable for oil-submerged operation.

These HV fuse-links can be manufactured with and without striker. Their contact caps can be fitted with threaded studs or nuts for the connection of cable lugs.

EFEN has developed a wide range of HV fuse-links for special applications which would be too numerous to list here. Whenever you are facing a non-standard protection task, we will be happy to assist you in finding an optimal solution!

## HV Fuse-Links

### General remarks

#### Protection of transformers

The following must be observed when selecting HV fuse-links:

- a) Transformer ratings
  - Rated operating voltage (U)
  - Rated output (S)
  - rel. short-circuit voltage ( $u_k$  %)
  - Inrush current ( $8... 12 I_N$ )
- b) Time-current characteristics of HV fuse-links
- c) Secondary protective devices/selectivity

Procedure explained using an example:

A 630 kVA transformer has a transformer rated current of 18.2 A at a rated operating voltage of 20 kV. The relative short-circuit voltage is 4%, and the inrush current is  $12 \times I_N$ . The short-circuit current on the secondary terminal short-circuit results from the relative short-circuit voltage. The transformer must be designed to withstand this current for 2 seconds. This condition results in point b) in Fig. 3. HV fuse-links must break this current within 2 seconds. In Fig. 3, fuse-link F4 must not be used for this transformer, as the fuse-link will require more than 2 seconds to melt at the given short-circuit current.

The inrush current is plotted for a duration of 0.1 seconds, resulting in point a). This inrush current must not melt the fuse-link. Accordingly, fuse-link F1 cannot be used for this transformer.

Fuse-links F2 and F3 may be used for this transformer since their time-current characteristics are between points a) and b). Several HV fuse-links for various rated currents can therefore be assigned to a transformer. The selection of the correct fuse must be based on the time-current characteristic and not the rated current of the HV fuse-link.

German standard VDE 0670 T402 defines time-current ranges for rated currents, taking into account points a) and b) as well as the selectivity to the NH fuse-links of utilization category gTr. If an HV fuse-link is assigned to a transformer according to part 402, all of the above factors must be taken into account to select the correct HV fuse-link.

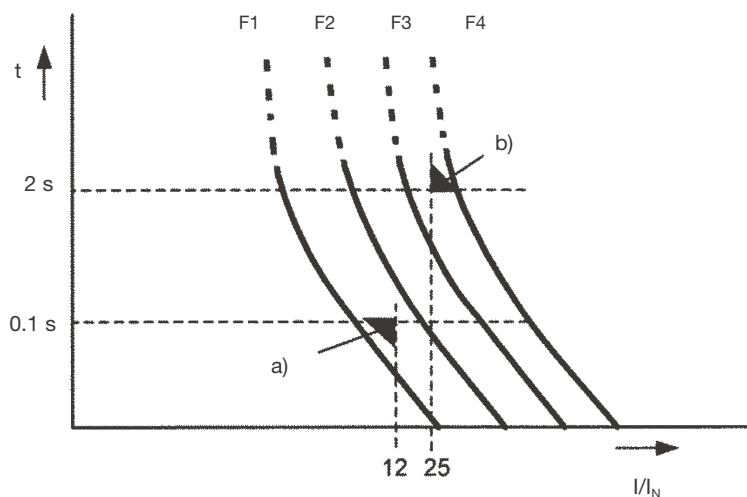

Fig. 3

- F1– F4) Time-current characteristics for HV fuse-links
- a) Inrush current
  - b) Lowest short-circuit current of the transformer

## HV Fuse-Links General remarks

### HV back-up Fuse-Links acc. to VDE 0670 T4 / IEC 60 282-1 with controlled power dissipation (ÜLA)

#### Application

EFEN HV back-up fuses of type ÜLA meet the requirements of VDE 0670 and are specifically designed for installation in compact, enclosed SF6-insulated substations. In these substations, the fuse-links are installed in tight compartments. These significantly affect heat dissipation and only absorb a limited amount of heat. However, overheating of fuse compartments in such enclosures is not to be expected if EFEN HV fuse-links have been properly selected and are matched to the transformer to be protected according to table 3, and if the fuse-links are in faultless condition (Fig. 4).

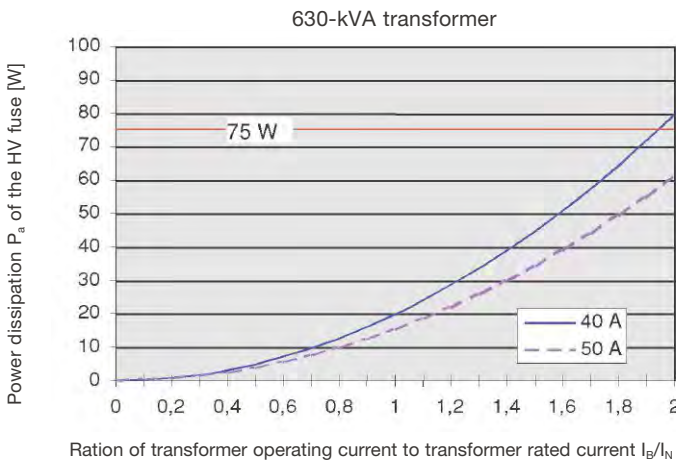

Fig. 4: Power dissipation of 40-A and 50-A HV fuse-links for a 20-kV 630-kVA transformer

One or more of the fuse elements connected in parallel may be interrupted by transient currents caused by transformer inrush or lightning current. As a result, fuses dissipate significantly more heat. There is a certain risk that the heat absorption limit for transformer rated current of the fuse compartments may be exceeded. EFEN HV back-up fuses of type ÜLA prevent such overheating when installed in conjunction with a transformer switch having a trip-free mechanism.

#### Operating mode

The average heat absorption of the fuse compartments is approximately 75 W. To prevent thermal overload, heat output  $P_a$  of the fuse must not exceed this limit:

$$P_a \leq 75 \text{ W}$$

The ÜLA striker system controls the power dissipation of the fuse as the tripping of the striker depends on the voltage, and power dissipation, accordingly:

$$U_a = R \cdot I_B$$

$$U_a \cdot I_B = P_a \leq 75 \text{ W}$$

The tripping voltage  $U_a$  of the ÜLA striker system has been selected so that, when multiplied by the operating current  $I_B$ , it will not exceed the limiting value, e.g. 75 W, if the resistance  $R$  of the fuse elements increases. In this case the ÜLA striker system controls the power dissipation of the fuse, triggering the transformer switch before the permissible power acceptance of the fuse compartment is exceeded (Fig. 5).

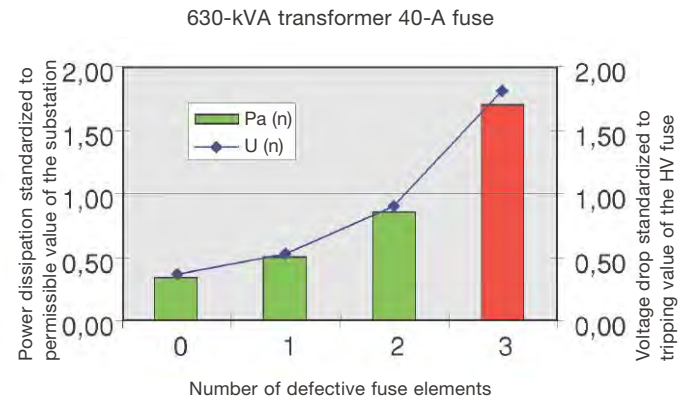

Fig. 5: Controlled power dissipation at 1.3 times the transformer rated current

#### Benefits of protection with controlled power dissipation (ÜLA)

- ÜLA controls the power dissipation of the fuse-links
- ÜLA is based on Ohm's law
- ÜLA works independently of the installation position of the fuse
- ÜLA trips the striker before the system overheats
- ÜLA is non-ageing

#### HV fuse-switch ÜLA Plus for switch-fuse combinations

The HV fuse-switch ÜLA Plus was specially designed for use in switch-fuse combinations. This product is characterized by low power dissipation and optimized breaking capacity, even at high rated currents.

- Fast-blowing: With regard to the requirements for switch-fuse combinations according to IEC 62271-105 / VDE 0671 T105, tripping speed in the range of 10 – 100ms was significantly increased. Letting the fuse perform the switching of the transformer short circuit current is a requirement. This is supported by the special characteristics of the fuse.
- Lower power dissipation: Reducing power dissipation by up to 30% allows protection with a switch-fuse combination even with large transformers and also reduces costs.
- Combined control system: The process of controlling temperature and power dissipation simultaneously allows excellent system protection.

The HV ÜLA Plus fuse-link is available from 6/12 kV to 20/36 kV. Thanks to the optimized characteristics, this line of fuse-links is especially suitable for use in gas-insulated SF6-substations.

## HV Fuse-Links

### General remarks

#### High-voltage switch-fuse combinations acc. to VDE 0671 T105 / IEC 62 271-105

Switches can be combined with current-limiting HV fuse-links to increase their utilization range. Such combinations offer short-circuit protection as well as load-switching capacity. HV fuse-links provide short-circuit protection while the switch interrupts the currents below the take-over current of the combination unit. Further to the inrush current, the short-circuit current on the secondary-terminal short-circuit and the low-voltage selectivity, the following switch characteristics must be taken into account:

- Rated transfer current ( $I_{transfer}$ )
- Switch response time ( $t_0$ )

Fig. 6 shows the rated transfer current ( $I_{transfer}$ ) as a vertical line. The switch response time ( $t_0$ ) must be multiplied by 0.9 (simplified procedure for characteristic gradient 4) and is shown as a horizontal line. This results in an intersection that is characteristic to load switches and must be established for each switch individually.

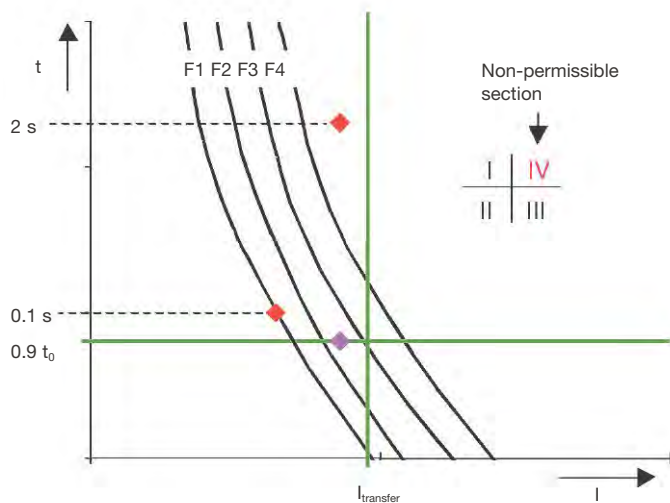

Fig. 6  
Selecting an HV fuse-link acc. to VDE 0671 T105 / IEC 62 271.105

This switch intersection divides the diagram into four quadrants (see Fig. 6). Only HV fuse-links with time-current characteristic that do not pass through quadrant IV ("non-permissible section") are suitable for the switch-fuse combination described. This means that all HV fuse-links with striker that meet this requirement can be used in switch-fuse combinations according to IEC 62 271-105. EFEN has assigned HV fuse-links to suitable switches and transformers for switchgear of all major manufacturers. These documents are available on request.

#### EFEN HV general-purpose Fuse-Links acc. to VDE 0670 T4 / IEC 60 282-1

EFEN HV general-purpose fuse-links have an extended breaking range for low currents. Connecting two fuse elements in series in one body results in specific time-current characteristic.

This allows a specific selectivity to be established between HV general-purpose fuse-links and low-voltage circuit breakers.

While one system can reliably interrupt low pre-arcing currents with long pre-arcing times (up to one hour), the other system is ready to break high short-circuit currents. Therefore, the time-current characteristic consists of two sections. The handover (intersection) point between the two systems is at approx. 1 second (see I/t characteristic F1 in Fig. 7).

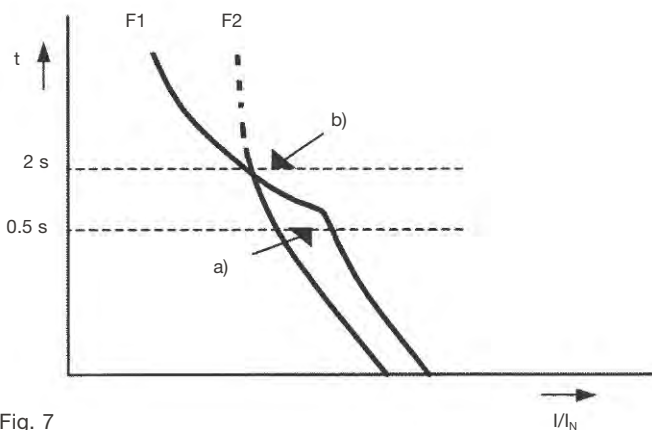

Fig. 7

- F1) Time-current characteristic of a general-purpose fuse-link  
 F2) Time-current characteristic of a back-up fuse-link  
 a) Selectivity to low-voltage circuit breaker  
 b) Lowest short-circuit current of the transformer

In Fig. 7, point b) corresponds to the short-circuit current of a transformer. Point a) is the tripping current of a circuit breaker on the low-voltage side set e.g. to a tripping time of 0.5 seconds, transferred to the high-voltage side. The transformer is protected by both fuse-links with I/t characteristic F1 and F2 as the short-circuit current is interrupted within 2 seconds. If a selectivity of the HV fuse-link to the circuit breaker (point a) is required, an EFEN HV general-purpose fuse-link must be used on the high-voltage side. Its time-current characteristic F1 is located to the right of point a) of the circuit-breaker, in contrast to I/t characteristic F2 of the HV back-up fuse-link which would already melt before the circuit breaker trips. Thanks to a special manufacturing process, these HV general-purpose fuse-links can also be produced as an oil-tight variants which can be directly integrated into the transformer. Such fuse-links do not have a striker and are provided with a threaded connection on both ends. They are suitable for oil-submerged operation inside the transformer.

# HV Fuse-Links

## Electrical data, dimensions, weight

Fuse-Links

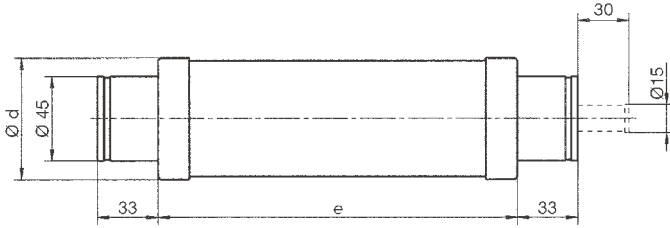
**Technical data**

HV back-up Fuse-Links acc. to VDE 0670 / IEC 60 282-1 with controlled power dissipation (ÜLA)

Order no.	Rated voltage range  Un kV	Rated current  In A	Rated value, Maximum breaking current  I1 kA	Rated value, Minimum breaking current  I3 A	Dimensions		Resistance and power dissipation		Operat- ing integral  A²s	Weight  kg	
					e mm	d mm	R initial mΩ	P warm W			
67523.0100	6/12	10	63	35	292	56	227	29	3.000	1,6	
67523.0160		16		64			66	21	3.700		
67523.0200		20		90			51	25	4.700		
67523.0250		25		95			40	29	4.920		
67523.0320		31,5		110			30	39	7.000		
67523.0400		40		134			20	46	14.000		
67523.0500		50	190	15	62	25.300					
67523.0630		63	80	250	65	11,9	58	52.200	2,1		
67523.0800		80		280	9,5	82	78.000				
67523.1000		100		330	78	7,4	103	152.000	2,3		
67523.1250		125		430	88	5,2	109	266.800	2,5		
67524.1000		100		325	442	78	7,5	100	169.500		
67524.1250	125	430		5,3			109	291.000	3,3		
67524.1600	160	460	4,4	175			358.500				
67543.0060	10/24	6,3	63	23	442	56	640	31	800	2,3	
67543.0100		10		36			386	48	2.000		
67543.0160		16		73			127	42	2.340		
67543.0200		20		91			97	53	3.900		
67543.0250		25		116			73	60	6.500		
67543.0320		31,5		125			57	84	7.000		
67543.0400		40	161	41	96	14.200					
67543.0500		50	210	65	27	89	27.900	3,1			
67543.0630		63	235	78	21	102	67.000	3,3			
67543.0800		80	265						17	153	92.500
67543.1000		100	345						13,6	200	152.000
67543.1250		125	435	88	10,1	254	279.000	5,9			
67553.0060	20/36	6,3	31,5	20	537	56	889	39	600	2,7	
67553.0100		10		33			529	66	2.000		
67553.0160		16		66			190	67	2.340		
67553.0200		20		95			153	84	3.900		
67553.0250		25		110			118	100	6.500		
67553.0320		31,5		135			65	82	119		7.000
67553.0400		40	200	63	176	14.200					
67553.0500		50	220	40	130	34.000					
67553.0630		63	35	250	88	31	165	72.500	6,5		
67553.0800		80		340						24	229

\* This rated current requires a reduction factor. Reduction factors are available on request.

# HV Fuse-Links

## Selection table for HV back-up Fuse-Links

VDE 0670 T402 with ÜLA Plus / selection table acc. to IEC 62271-105

		Transformer rated output in kVA															
Rated voltage range of the fuse-link (kV)		U <sub>K</sub> = 4 %									U <sub>K</sub> = 6 %						
Rated operating voltage of the transformer		100	125	160	200	250	315	400	500	630	630	800	1000	1250	1600	2000	2500
6/12 10	Transformer rated current in A	5,8	7,2	9,2	11,5	14,4	18,2	23,1	28,9	36,4	36,4	46,2	57,7	72,2	92,4		
	Short-circuit current 2s in A	144	180	231	289	361	455	577	722	909	606	770	962	1203	1540		
	Transfer current I transfer in A T <sub>0</sub> = 40 ms	143	143	184	258	321	433	567	512	660	512	660	837	1135	1320		
	Rated current of the fuse-link in A	16	16	20	25	31,5	40	50	63	80	63	80	100	125	160		
	Power dissipation of the fuse-link IN transf. in W	1,9	3,0	3,4	4,7	5,3	6,9	8,3	8,1	11,3	14,0	19,8	24,1	26,3	42,2		
10/24 20	Transformer rated current in A	2,9	3,6	4,6	5,8	7,2	9,1	11,5	14,4	18,2	18,2	23,1	28,9	36,1	46,2	57,7	72,2
	Short-circuit current 2s in A	72	90	115	144	180	227	289	361	455	303	385	481	601	770	962	1203
	Transfer current I transfer in A	72	72	72	136	173	239	239	310	436	307	436	450	562	701	860	1184
	Rated current of the fuse-link in A	10	10	10	16	20	25	25	31,5	40	31,5	40	50	63	80	100	125
	Power dissipation of the fuse-link IN transf. in W	2,6	4,0	6,7	4,0	4,8	5,8	9,7	11,8	13,2	20,2	23,1	23,6	24,1	36,9	48,2	61,2
20/36 30	Transformer rated current in A	1,9	2,4	3,1	3,8	4,8	6,1	7,7	9,6	12,1	12,1	15,4	19,2	24,1	30,8	38,5	48,1
	Short-circuit current 2s in A	48	60	77	96	120	152	192	241	303	202	257	321	401	513	642	802
	Transfer current I transfer in A T <sub>0</sub> = 40 ms	39	39	71	71	71	139	181	181	228	181	228	315	400	450	577	731
	Rated current of the fuse-link in A	6,3	6,3	10	10	10	16	20	20	25	20	25	31,5	40	50	63	80
	Power dissipation of the fuse-link IN transf. in W	2,4	3,7	4,1	6,3	6,1	3,6	6,3	13,1	15,9	22,8	28,3	33,0	46,9	51,7	45,7	61,0

## HV Fuse-Links General remarks

### High-voltage Fuse-Links for voltage transformer "HSW" acc. to VDE 0670 T4 / IEC 60 282-1

HV fuse-links for voltage transformers (HSW) offer protection against short-circuits. They reliably isolate the defective transformer from the power supply.

Their compact design enables integration into the transformer housing. By sealing the transformer housing with a screw cap, the HSW can be replaced and is visible from outside if the screw cap has a window. For status indication purposes, the HSW can be provided with an indicator. The HSW can be used for transformers with an output limit of up to 3000 VA (6 to 12 kV) or 6000 VA (15 to 24 kV).

In the event of a short-circuit, the HSW significantly reduces the current in such a way that the maximum peak current of 1 kA flows only for a few microseconds. In this way, effects of the defect on the supplying system are largely prevented.



Fig. 8

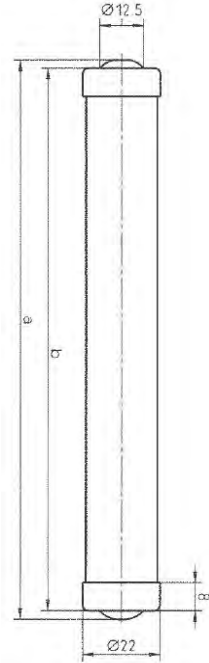

Fig. 9

### HV Fuse-Links for voltage transformers

#### Electrical data, dimensions, weight

Variant	Rated voltage range $U_N$ kV	Dimensions		Initial resistance	Weight kg	PU	Order no.
		a mm	b mm	$R_{initial}$ max. $\Omega$			
with indicator	6/12	160	155	7	0,15	1	67036-0004
with indicator	15/24	280	275	12	0,27	1	67037-0004
without indicator	6/12	160	155	7	0,15	1	67036-0003
without indicator	15/24	280	275	12	0,27	1	67037-0003
without indicator	20/36	421	-	9	2,7	1	67088-0003

# HV Fuse-Links

## Selection table acc. to VDE 0670 T402 / IEC 60 282-1

Selection table for HV back-up Fuse-Links acc. to VDE 0670 T402 / IEC 60 282-1 with selectivity to the low-voltage fuse-link (gTr/gG)

Table 1

Rated voltage range of the fuse-link [kV]	Mode of protection, rated current of the fuse-link [A]	Transformer rated output [kVA]											
		Rel. short circuit voltage						u <sub>K</sub> = 4 %				u <sub>K</sub> = 5 %	
		50	100	125	160	200	250	315	400	500	630	800	1000
3/7,2	I <sub>N</sub> Tr	4,8	9,6	12,0	15,4	19,2	24,1	30,3	38,5	48,1	60,6	77,1	96,3
	with NH gG	16	<b>20-25</b>	<b>25-31,5</b>	<b>31,5-40</b>	<b>40-50</b>	<b>50-63</b>	<b>63-80</b>	<b>80-100</b>	<b>100-125</b>	<b>100-160</b>	160	160
6	with NH gTr		<b>20-25</b>	<b>25-31,5</b>	<b>31,5-40</b>	<b>40-50</b>	<b>50-63</b>	<b>63-80</b>	<b>80-100</b>	<b>100-125</b>	<b>100-160</b>	160	160
	I <sub>N</sub> Tr	2,9	5,8	7,2	9,2	11,5	14,4	18,2	23,1	28,9	36,4	46,2	57,7
6/12	with NH gG	10	16	16	<b>20-25</b>	<b>25-31,5</b>	<b>31,5-40</b>	<b>40-50</b>	<b>50-63</b>	<b>63-80</b>	<b>80-100</b>	<b>100-125</b>	<b>100-125</b>
	with NH gTr		16	16	<b>20-25</b>	<b>25-31,5</b>	<b>31,5-40</b>	<b>40-50</b>	<b>50-63</b>	<b>63-80</b>	<b>80-100</b>	<b>100-125</b>	<b>100-160</b>
10/24	I <sub>N</sub> Tr	1,5	2,9	3,6	4,6	5,8	7,2	9,1	11,5	14,4	18,2	23,1	28,9
	with NH gG	6,3	10	10	16	16	<b>16-25</b>	25	<b>25-31,5</b>	<b>31,5-40</b>	<b>40-50</b>	63	63
20	with NH gTr		10	10	16	16	<b>16-25</b>	25	<b>25-31,5</b>	<b>31,5-40</b>	<b>40-50</b>	63	63-80
	I <sub>N</sub> Tr	1,0	1,9	2,4	3,1	3,8	4,8	6,1	7,7	9,6	12,1	15,4	19,2
20/36	with NH gG		6,3	10	10	16	<b>16-20</b>	<b>20-25</b>	25	<b>25-31,5</b>	<b>31,5-40</b>	<b>40-50</b>	<b>40-50</b>
	with NH gTr		6,3	10	10	16	<b>16-20</b>	<b>20-25</b>	25	<b>25-31,5</b>	<b>31,5-40</b>	<b>40-50</b>	<b>40-50</b>
0,4	I <sub>N</sub> Tr	72	144	180	231	289	361	455	577	722	909	1155	1443
	with NH gG	80	125/160	160/200	200/250	250/315	315/400	400/500	500/630	630/800	800/1000	1000/1250	1250/1600
	with NH gTr		100	125	160	200	250	315	400	500	630	800	1000

Preferred values shown in bold print

I<sub>N</sub> Tr = Transformer rated current [A]

Selection table for HV back-up Fuse-Links acc. to VDE 0670 T402 with selectivity to NH gTr with controlled power dissipation (ÜLA)

Table 2

Rated voltage range of the fuse-link [kV]	Mode of protection, rated current of the fuse-link [A]	Transformer rated output [kVA]											
		Rel. short circuit voltage						u <sub>K</sub> = 4 %				u <sub>K</sub> = 5 %	
		100	125	160	200	250	315	400	500	630	800	1000	
6/12	I <sub>N</sub> Tr	5,8	7,2	9,2	11,5	14,4	18,2	23,1	28,9	36,4	46,2	57,7	
	I <sub>N</sub>	16	16	20	25	31,5	40	50	63	80	100	125	
10	P <sub>warm</sub>	2,4	3,6	4,5	5,3	6,3	8,6	10,7	10,4	13,1	28,5	18,3	
	I <sub>N</sub> Tr	2,9	3,6	4,6	5,8	7,2	9,1	11,6	14,4	18,2	23,1	28,9	
10/24	I <sub>N</sub>	10	10	16	16	16/25	25	25/31,5	31,5	40	63	63	
	P <sub>warm</sub>	3,3	5,0	2,9	4,6	7,2/3,8	6,2	10,2/8,3	13,0	15,2	14,0	22,7	
20/36	I <sub>N</sub> Tr	1,9	2,4	3,1	3,8	4,8	6,1	7,7	9,6	12,1	15,4	19,2	
	I <sub>N</sub>	6,3	10	10	16	16	20	25	25	31,5	40	40/50	
30	P <sub>warm</sub>	2,8	3,0	4,7	3,0	4,5	5,6	6,5	10,0	12,3	16,9	27,6/17,3	

I<sub>N</sub> Tr = Transformer rated current [A]

I<sub>N</sub> = Fuse-link rated current [A]

P<sub>warm</sub> = Power dissipation of the HV fuse-links for rated current of the transformer [W]

## HV Fuse-Links

### Selection table acc. to VDE 0670 T4 / IEC 60 282-1

Selection table for EFEN HV general-purpose fuses  
VDE 0670 T4 / IEC 60282-1

Table 3

Rated voltage range of the fuse-link [kV]	Mode of protection, fuse-link rated current [A]	Transformer rated output [kVA]											
		Rel. short circuit voltage $u_k = 4\%$										$u_k = 5\%$	
		50	100	125	160	200	250	315	400	500	630	800	1000
3/7,2	$I_{N Tr}$	4,8	9,6	12	15,4	19,2	24,1	30,3	38,5	48,1	60,6	77,1	96,3
	$I_N$	6,3	16	16	16-25	25	25-40	40	40-50	50	50	-	-
6/12	$I_{N Tr}$	2,9	5,8	7,2	9,2	11,5	14,4	18,2	23,1	28,9	36,4	46,2	57,7
	$I_N$	6,3	6,3-10	10	16	16	16-25	25	25-40	40	40-50	50	50
10/24	$I_{N Tr}$	1,5	2,9	3,6	4,6	5,8	7,2	9,1	11,5	14,4	18,2	23,1	28,9
	$I_N$	-	4	4-6,3	6,3	6,3-10	10	16	16	16	25	25	25

$I_{N Tr}$  = Transformer rated current [A]  
 $I_N$  = Fuse-link rated current [A]

#### Benefits of using EFEN HV general-purpose Fuse-Links:

- Reliable breaking of all currents: from the current tripping the fuse element within a time of  $\geq 1$  hour to the maximum rated breaking current  $I_1$
- No lightning current and low inrush current sensitivity
- Very low power dissipation/low thermal load
- Selectivity to low-voltage circuit breaker possible
- EFEN HV general-purpose fuse-links are available as oil-tight variants for integration into transformers

# HV Fuse-Links

## Selection table acc. to VDE 0670 T4 and T 402 / IEC 60 282-1

### HV Fuse-Links for protection of HV motors

EFEN HV fuse-links are suitable for HV motor protections.

EFEN has the expertise and the right products to protect your motor circuits effectively.

Selection table acc. to T402

Table 4

High-voltage motors	Number of starts per h	Maximum motor starting current (A)							
		Start-up times							
≤ 6 s	≤ 2	130	180	220	290	360	500	680	1100
	4	120	150	190	240	310	450	550	900
	10	110	140	170	220	270	400	490	770
	15	100	130	160	200	250	340	430	670
	30	90	120	140	190	230	320	400	630
6 – 15 s	2	120	160	190	240	310	430	580	670
	4	100	140	170	220	280	400	500	610
	10	90	120	150	200	240	340	430	540
	15	80	110	130	180	220	320	400	480
	30	70	100	120	160	200	290	350	430
15 – 60 s	2	100	130	160	220	270	380	470	590
	4	90	120	150	200	250	340	440	540
	6	80	110	140	190	230	320	400	500
	10	70	100	130	180	220	300	380	470

recommended fuse-link (acc. to IEC 60282-1 and VDE 0670 T4 & 402)

Rated current:	63 A	80 A	100 A	125 A	160 A	2 x 100 A	2 x 125 A	2 x 160 A	
Order number									
Motor rated voltage	3 – 7,2 kV	67110-0630	67110-0800	67110-1000	67110-1250	67110-1600	67110-1000	67110-1250	67110-1600
	6 – 12 kV	67120-0630	67120-0800	67120-1000	67120-1250	67120-1600	67120-1000	67120-1250	67120-1600
	10 – 24 kV	67140-0630	67140-0800	67140-1000					
	20 – 36 kV	67150-0630							

Selection table acc. to T4

Table 5

High-voltage motors	Number of starts per h	Maximum motor starting current (A)							
		Start-up times							
≤ 6 s	≤ 2	120	165	210	320	370	430	900	1050
	4	110	140	180	275	320	380	730	870
	10	100	130	160	240	280	330	620	750
	15	90	120	150	220	260	300	560	650
	30	80	110	135	205	240	280	510	600
6 – 15 s	2	115	145	180	270	320	370	590	640
	4	95	125	160	240	280	340	530	570
	10	85	110	140	210	250	300	480	510
	15	75	100	120	190	230	280	430	450
	30	65	90	110	170	210	250	380	400
15 – 60 s	2	90	120	150	240	280	320	520	550
	4	80	110	140	220	260	290	470	510
	6	75	100	130	205	240	270	430	470
	10	65	90	120	195	230	250	400	440

recommended fuse-link (acc. to IEC 60282-1 and VDE 0670 T4 & 402)

Rated current:	63 A	80 A	100 A	160 A	200 A	2 x 100 A	2 x 160 A	2 x 200 A	
Order number									
Motor rated voltage	3 – 7,2 kV	67210-0630	67210-0800	67210-1000	67210-1600	67210-2000	67210-1000	67210-1600	67210-2000
	6 – 12 kV		67220-0800	67220-1000	67220-1600	67220-2000	67220-1000	67220-1600	67220-2000
	10 – 24 kV		67240-0800	67240-1000					

## HV Fuse-Links

### Selection table acc. to VDE 0670 T4 / IEC 60 282-1

Selection table for capacitors

Table 6

Rated voltage range of the fuse-link [kV]	3/7,2		6/12		10/24		20/36	
Rated operating voltage of the capacitor [kV]	3		6		10		20	
Capacitor Rated output [kVAr]	I <sub>cr</sub> [A]	I <sub>r</sub> [A] Fuse-link	I <sub>cr</sub> [A]	I <sub>r</sub> [A] Fuse-link	I <sub>cr</sub> [A]	I <sub>r</sub> [A] Fuse-link	I <sub>cr</sub> [A]	I <sub>r</sub> [A] Fuse-link
		Order no.:		Order no.:		Order no.:		Order no.:
50	9,6	20 67110-0200	4,8	10 67220-0100	2,9	6,3 67240-060	1,44	4 67250-0040
100	19,2	40 67110-0400	9,6	20 67220-0200	5,8	10 67240-0100	2,9	6,3 67150-0060
125	24,1	50 67110-0500	12,0	25 67220-0250	7,2	16 67240-0160	3,6	6,3 67150-0060
160	30,8	80 67210-0800	15,4	31,5 67220-0320	9,2	20 67240-0200	4,6	10 67150-0100
200	38,5	100 67210-1000	19,2	50 67220-0500	11,5	25 67240-0250	5,8	16 67150-0160
250	48,1	125 67110-1250	24,1	63 67220-0630	14,4	31,5 67240-0320	7,2	16 67150-0160
315	60,6	160 67210-1600	30,3	80 67220-0800	18,2	50 67240-0500	9,1	20 67150-0200
400	77,0	200 67210-2000	38,5	100 67220-1000	23,1	63 67240-0630	11,5	25 67150-0250
500	96,2	2 x 125 2 x 67110-1250	48,1	125 67220-1250	28,9	80 67240-0800	14,4	31,5 67150-0320
630	121,2	2 x 160 2 x 67210-1600	60,6	160 67220-1600	36,4	100 67240-1000	18,2	40 67150-0400
800	154,0	2 x 200 2 x 67210-2000	77,0	200 67220-2000	46,2	125 67240-1250	23,1	50 67150-0500
1000	192,5	3 x 160 3 x 67210-1600	96,2	2 x 125 2 x 67220-2000	57,7	160 67240-1600	28,9	63 67150-0630

#### Selection table for capacitor protection with HV back-up fuse-links according to VDE 0670 T4 / IEC 60282-1

When switching on and adjusting capacitors, transient currents similar to a short-circuit are generated. The intensity and duration of these currents depends on the switching angle, natural frequency and inductivity of the grid and on the size of the capacitors. Therefore, HV fuse-links with the next higher voltage level should be selected to protect individual capacitors.

The following table complies with the requirements of IEC 549 "High-voltage fuses for the external protection of shunt power capacitors".

#### Definitions:

I<sub>cr</sub> = Capacitor rated current [A]

I<sub>r</sub> = Fuse-link rated current [A]

# HV Fuse-Links

## Selection table acc. to VDE 0670 T4 / IEC 60 282-1

### Selection table

HV back-up Fuse-Links acc. to VDE 0670 T4 / IEC 60 282-1 with controlled power dissipation (ÜLA)

Table 7

Rated voltage range of the fuse-link [kV]		6/12		10/24	
Rated operating voltage of the transformer [kV]		10		20	
Rel. short-circuit voltage	Transformer rated output [kVA]	Transformer rated current [A]	Fuse-link rated current [A]	Transformer rated current [A]	Fuse-link rated current [A]
U <sub>k</sub> = 4 %	<b>50</b>	2,9	10	1,5	4
	<b>100</b>	5,8	<b>16 - 20</b>	2,9	10
	<b>125</b>	7,2	<b>20 - 25</b>	3,6	<b>10 - 16</b>
	<b>160</b>	9,2	<b>20 - 31,5</b>	4,6	<b>16 - 20</b>
	<b>200</b>	11,5	<b>25 - 40</b>	5,8	<b>16 - 20</b>
	<b>250</b>	14,4	<b>31,5 - 50</b>	7,2	<b>20 - 25</b>
	<b>315</b>	18,2	<b>40 - 63</b>	9,1	<b>20 - 31,5</b>
	<b>400</b>	23,1	<b>40 - 80</b>	11,5	<b>25 - 40</b>
	<b>500</b>	28,9	<b>50 - 100</b>	14,4	<b>31,5 - 50</b>
U <sub>k</sub> = 5 %	<b>630</b>	36,4	<b>63 - 100</b>	18,2	<b>40 - 63</b>
	<b>800</b>	46,2	<b>80 - 125</b>	23,1	<b>40 - 63</b>
	<b>1000</b>	57,7	<b>100 - 160</b>	28,9	<b>50 - 80</b>
U <sub>k</sub> = 6,25 %	<b>1250</b>	72,2	<b>125 - 200</b>	36,1	<b>63 - 100</b>
	<b>1600</b>	92,4	<b>125 - 200</b>	46,2	<b>80 - 100</b>

Preferred values shown in bold print

### Selection table

HV back-up Fuse-Links acc. to VDE 0670 T4 / IEC 60 282-1

Table 8

Rated voltage range of the fuse-link [kV]		3/7,2		6/12		10/24		20/36	
Rated operating voltage of the transformer [kV]		6		10		20		30	
Rel. short circuit voltage	Transformer rated output [kVA]	Transformer rated current [A]	Fuse-link rated current [A]	Transformer rated current [A]	Fuse-link rated current [A]	Transformer rated current [A]	Fuse-link rated current [A]	Transformer rated current [A]	Fuse-link rated current [A]
U <sub>k</sub> = 4 %	<b>50</b>	4,8	<b>16 - 20</b>	2,9	10	1,5	4	0,96	<b>2 - 6,3</b>
	<b>100</b>	9,6	<b>20 - 31,5</b>	5,8	<b>16 - 20</b>	2,9	10	1,9	<b>6,3 - 10</b>
	<b>125</b>	12	<b>25 - 40</b>	7,2	<b>20 - 25</b>	3,6	<b>10 - 16</b>	2,4	10
	<b>160</b>	15,4	<b>31,5 - 50</b>	9,2	<b>20 - 31,5</b>	4,6	<b>16 - 20</b>	3,1	10
	<b>200</b>	19,2	<b>40 - 63</b>	11,5	<b>25 - 40</b>	5,8	<b>16 - 20</b>	3,8	<b>10 - 16</b>
	<b>250</b>	24,1	<b>40 - 80</b>	14,4	<b>31,5 - 50</b>	7,2	<b>20 - 25</b>	4,8	<b>16 - 20</b>
	<b>315</b>	30,3	<b>50 - 100</b>	18,2	<b>40 - 63</b>	9,1	<b>20 - 31,5</b>	6,1	<b>16 - 25</b>
	<b>400</b>	38,5	<b>63 - 125</b>	23,1	<b>40 - 80</b>	11,5	<b>25 - 40</b>	7,7	<b>20 - 25</b>
	<b>500</b>	48,1	<b>80 - 160</b>	28,9	<b>50 - 100</b>	14,4	<b>31,5 - 50</b>	9,6	<b>20 - 31,5</b>
	<b>630</b>	60,6	<b>100 - 200</b>	36,4	<b>63 - 100</b>	18,2	<b>40 - 63</b>	12,1	<b>25 - 40</b>
U <sub>k</sub> = 5 %	<b>800</b>	77,1	<b>125 - 200</b>	46,2	<b>80 - 125</b>	23,1	<b>40 - 63</b>	15,4	<b>31,5 - 40</b>
	<b>1000</b>	96,3	<b>125 - 160</b>	57,7	<b>100 - 160</b>	28,9	<b>50 - 80</b>	19,2	<b>40 - 50</b>
	<b>1250</b>	120,3	<b>160 - 200</b>	72,2	<b>125 - 200</b>	36,1	<b>63 - 100</b>	24,1	<b>40 - 50</b>
U <sub>k</sub> = 6,25 %	<b>1600</b>	154	200	92,4	<b>125 - 200</b>	46,2	<b>80 - 100</b>	30,8	<b>50 - 63</b>

Preferred values shown in bold print

## HV Fuse-Links

 HV back-up Fuse-Links acc. to VDE 0670 T402 / IEC 60 282-1  
 Electrical data, dimensions, weight

Table 9

Rated voltage range	Rated current	Rated value Maximum breaking current	Rated value Minimum breaking current	Dimensions		Resistance and power dissipation		Operating integral	Weight	PU	Order no.
				e mm	d mm	R <sub>initial</sub> mΩ	P <sub>warm</sub> W				
U <sub>N</sub> kV	I <sub>N</sub> A	I <sub>1</sub> kA	I <sub>3</sub> A	e mm	d mm	R <sub>initial</sub> mΩ	P <sub>warm</sub> W	A <sup>2</sup> s	kg		
3/7,2	6,3	63	21	192	56	256	11	800	1,2	1	67110-0060
3/7,2	10	63	38	192	56	144	19	3.000	1,2	1	67110-0100
3/7,2	16	63	65	192	56	41	13	2.340	1,2	1	67110-0160
3/7,2	20	63	92	192	56	32	14,5	3.900	1,1	1	67110-0200
3/7,2	25	63	110	192	56	25	20	4.900	1,2	1	67110-0250
3/7,2	31,5	63	123	192	56	19	23	7.000	1,2	1	67110-0320
3/7,2	40	63	140	192	56	12,3	30	14.000	1,2	1	67110-0400
3/7,2	50	63	194	192	56	9,3	35	25.300	1,2	1	67110-0500
3/7,2	63	63	220	192	65	7,0	60	61.700	1,4	1	67110-0630
3/7,2	80	63	300	192	65	5,2	85	87.400	1,6	1	67110-0800
3/7,2	100	63	440	192	78	4,0	96	180.000	2,0	1	67110-1000
3/7,2	125	63	440	192	88	2,9	75	440.000	2,4	1	67110-1250
3/7,2	160	63	610	192	88	2,3	120	654.000	2,7	1	67110-1600
6/12	6,3	63	23	292	56	409	19	800	1,7	1	67120-0060
6/12	10	63	35	292	56	231	29	3.000	1,7	1	67120-0100
6/12	16	63	64	292	56	69	21	3.700	1,7	1	67120-0160
6/12	20	63	90	292	56	53	25	4.700	1,6	1	67120-0200
6/12	25	63	95	292	56	41	31	4.920	1,7	1	67120-0250
6/12	31,5	63	110	292	56	31	39	7.000	1,7	1	67120-0320
6/12	40	63	134	292	56	20	46	14.000	1,7	1	67120-0400
6/12	50	63	190	292	56	16,7	62	25.300	1,7	1	67120-0500
6/12	63	63	220	292	65	11,7	60	63.000	2,1	1	67120-0630
6/12	80	63	345	292	65	8,7	82	87.000	2,3	1	67120-0800
6/12	100	63	400	292	78	6,7	96	180.000	3,1	1	67120-1000
6/12	125	63	480	292	88	4,9	117	440.000	3,7	1	67120-1250
6/12	160	63	610	292	88	3,8	175	654.000	1,9	1	67120-1600
10/17,5	6,3	63	20	367	56	530	24	800	1,9	1	67130-0060
10/17,5	10	63	33	367	56	312	34	3.000	1,9	1	67130-0100
10/17,5	16	63	64	367	56	100	34	2.340	1,9	1	67130-0160
10/17,5	20	63	80	367	56	75	42	3.900	1,9	1	67130-0200
10/17,5	25	63	100	367	56	56	50	6.500	1,9	1	67130-0250
10/17,5	31,5	63	110	367	56	46	61	7.000	1,9	1	67130-0320
10/17,5	40	63	134	367	56	32	83	14.200	1,9	1	67130-0400
10/17,5	50	63	180	367	56	22	84	40.000	3,5	1	67130-0500
10/17,5	63	63	240	367	56	16	110	61.700	3,5	1	67130-0630
10/17,5	80	63	320	367	78	13	130	87.400	3,5	1	67130-0800
10/17,5	100	63	420	367	78	9,5	180	170.000	4,4	1	67130-1000
10/24	6,3	63	23	442	56	640	32	800	2,4	1	67140-0060
10/24	10	63	36	442	56	386	48	2.000	2,4	1	67140-0100
10/24	16	63	73	442	56	127	43	2.340	2,4	1	67140-0160
10/24	20	63	91	442	56	97	53	3.900	2,3	1	67140-0200
10/24	25	63	116	442	56	74	64	6.500	2,4	1	67140-0250
10/24	31,5	63	125	442	56	61	85	7.000	2,4	1	67140-0320
10/24	40	63	161	442	56	43	103	14.200	2,3	1	67140-0400
10/24	50	63	230	442	56	35	146	24.200	4,5	1	67140-0500
10/24	63	63	350	442	65	25	163	46.400	3,1	1	67140-0630
10/24	80	63	460	442	65	19	196	104.000	4,5	1	67140-0800
10/24	100	63	420	442	88	14	279	140.000	4,1	1	67140-1000
20/36	6,3	31,5	23	537	56	827	39	600	2,8	1	67150-0060
20/36	10	31,5	34	537	56	463	65	2.000	2,8	1	67150-0100
20/36	16	31,5	70	537	56	210	67	2.340	2,7	1	67150-0160
20/36	20	31,5	100	537	56	165	84	3.900	2,8	1	67150-0200
20/36	25	31,5	110	537	56	125	100	6.500	2,8	1	67150-0250
20/36	31,5	31,5	135	537	56	85	119	7.000	3,7	1	67150-0320
20/36	40	20	205	537	56	65	176	14.200	3,8	1	67150-0400
20/36	50	20	220	537	56	42	183	40.000	6,5	1	67150-0500
20/36	63	20	360	537	65	35	271	61.700	6,8	1	67150-0630

# HV Fuse-Links

HV back-up Fuse-Links acc. to VDE 0670 T402 and T402 ÜLA

Time-current characteristics

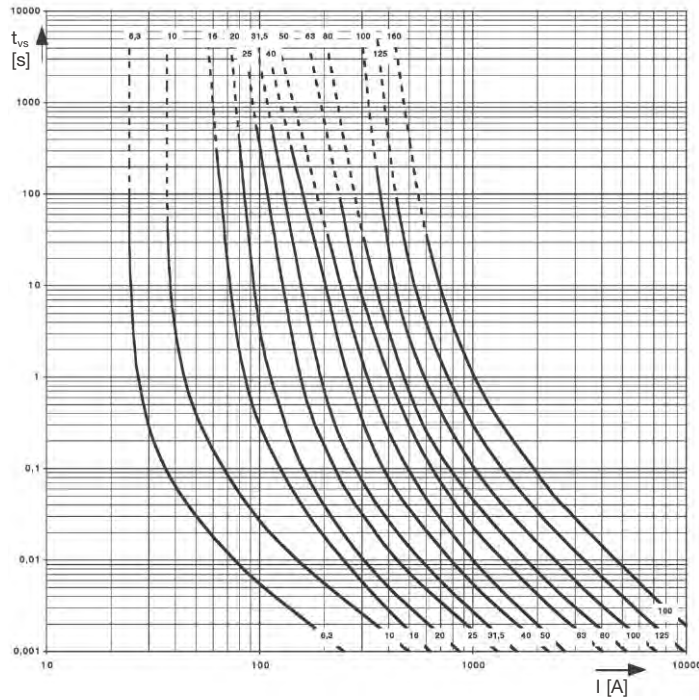

Fig. 10  
3/7.2 kV

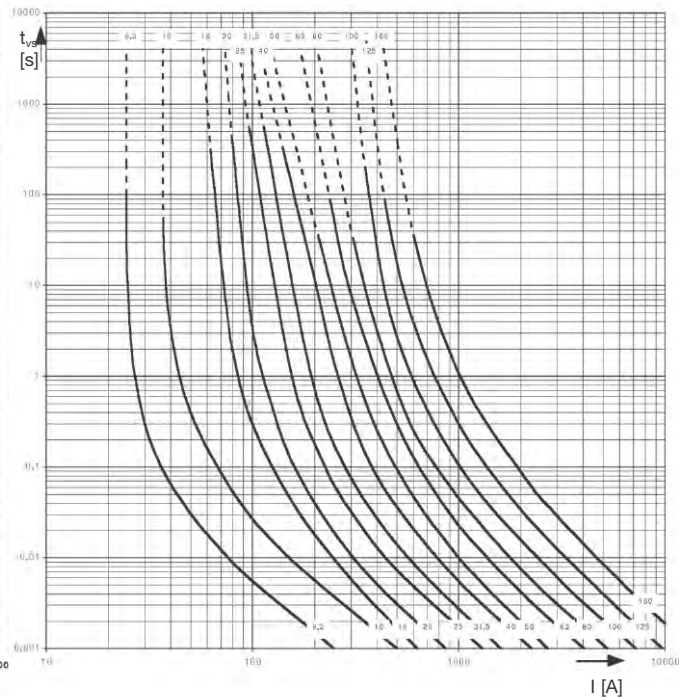

Fig. 11  
6/12 kV

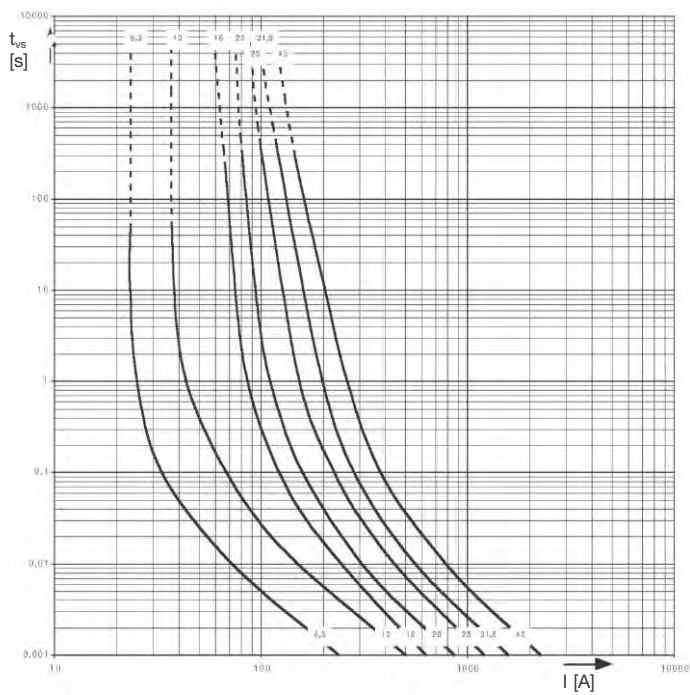

Fig. 12  
10/24 kV 6.3 A – 40 A

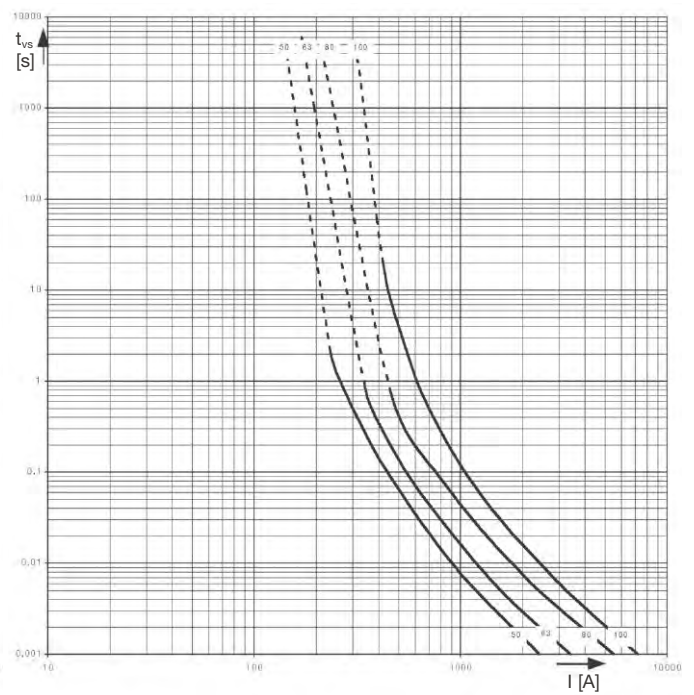

Fig. 13  
10/24 kV 50 A – 100 A

# HV Fuse-Links

Fuse-Links

HV back-up Fuse-Links acc. to VDE 0670 T402 and T402 ÜLA

Time-current characteristics

Dimensions acc. to DIN 43 625 in mm

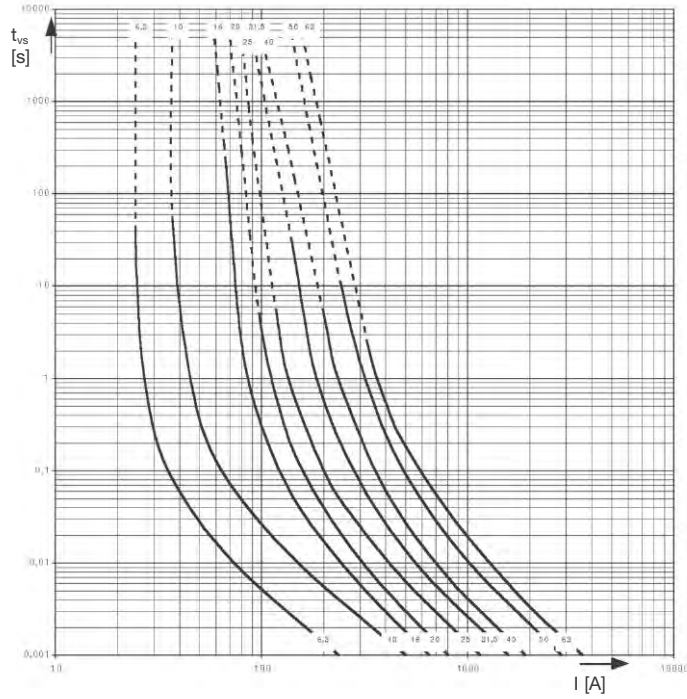
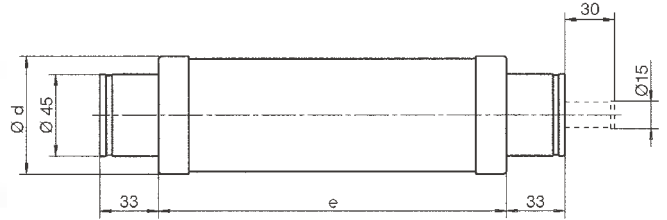

Fig. 14  
20/36 kV



# HV Fuse-Links

HV back-up Fuse-Links acc. to VDE 0670 T402 / IEC 60 282-1 with controlled power dissipation  $\dot{U}LA$

Electrical data, dimensions, weight

Table 10

Rated voltage range	Rated current	Rated value Maximum breaking current	Rated value Minimum breaking current	Dimensions		Resistance and power dissipation		Operating integral	Weight	PU	Order no.
				e mm	d mm	R <sub>initial</sub> mΩ	P <sub>warm</sub> * W				
U <sub>N</sub> kV	I <sub>N</sub> A	I <sub>1</sub> kA	I <sub>3</sub> A					A <sup>2</sup> s	kg		
6/12	10	63	35	292	56	227	29	3.000	1,6	1	67520-0100
6/12	16	63	64	292	56	66	21	3.700	1,6	1	67520-0160
6/12	20	63	90	292	56	51	25	4.700	1,6	1	67520-0200
6/12	25	63	95	292	56	40	29	4.920	1,6	1	67520-0250
6/12	31,5	63	110	292	56	30	39	7.000	1,6	1	67520-0320
6/12	40	63	134	292	56	20	46	14.000	1,6	1	67520-0400
6/12	50	63	190	292	56	15	62	25.300	1,6	1	67520-0500
6/12	63	63	220	292	65	12	62	63.000	2,1	1	67520-0630
6/12	80	63	345	292	65	8,7	85	87.000	2,1	1	67520-0800
6/12	100	63	500	292	65	8,1	152	140.000	2,1	1	67520-1000
6/12	125	63	480	292	88	4,5	117	430.000	3,7	1	67520-1250
6/12	160	63	610	292	88	4,0	175	670.000	3,7	1	67520-1600
10/24	6,3	63	23	442	56	640	31	800	2,3	1	67541-0060
10/24	10	63	36	442	56	386	48	2.000	2,3	1	67541-0100
10/24	16	63	73	442	56	127	42	2.340	2,3	1	67541-0160
10/24	20	63	91	442	56	97	53	3.900	2,3	1	67541-0200
10/24	25	63	116	442	56	73	60	6.500	2,3	1	67541-0250
10/24	31,5	63	125	442	56	57	84	7.000	2,3	1	67541-0320
10/24	40	63	161	442	56	41	96	14.200	2,3	1	67541-0400
10/24	50	63	230	442	65	35	146	24.200	3,1	1	67541-0500
10/24	63	63	350	442	65	24	163	46.400	3,1	1	67541-0630
10/24	80	63	460	442	65	19	196	104.000	3,1	1	67541-0800
10/24	100	63	420	442	88	14	279	140.000	4,1	1	67541-1000
20/36	6,3	31,5	23	537	56	889	39	600	2,7	1	67550-0060
20/36	10	31,5	34	537	56	529	66	2.000	2,7	1	67550-0100
20/36	16	31,5	70	537	56	190	67	2.340	2,7	1	67550-0160
20/36	20	31,5	100	537	56	153	84	3.900	2,7	1	67550-0200
20/36	25	31,5	110	537	56	118	100	6.500	2,7	1	67550-0250
20/36	31,5	31,5	135	537	65	82	119	7.000	3,7	1	67550-0320
20/36	40	20	205	537	65	63	176	14.200	3,7	1	67550-0400
20/36	50	20	220	537	88	41	183	40.000	6,5	1	67550-0500

\* Power dissipation P<sub>warm</sub> at HV fuse-link rated current; for power dissipation at transformer rated current see table 2

## HV Fuse-Links

HV back-up Fuse-Links acc. to VDE 0670 T4 / IEC 60 282-1

Table 11

## Electrical data, dimensions, weight

Rated voltage range	Rated current	Rated value Maximum breaking current	Rated value Minimum breaking current	Dimensions		Resistance and power dissipation		Operating integral	Weight	PU	Order no.
				e mm	d mm	R <sub>initial</sub> mΩ	P <sub>warm</sub> * W				
U <sub>N</sub> kV	I <sub>N</sub> A	I <sub>1</sub> kA	I <sub>3</sub> A					A2s	kg		
3/7,2	2	63	15	192	56	290	1,8	600	1,1	1	67210-0020
3/7,2	4	63	20	192	56	270	5	800	1,1	1	67210-0040
3/7,2	6,3	63	21	192	56	256	11	800	1,1	1	67110-0060
3/7,2	10	63	38	192	56	144	19	3.000	1,1	1	67110-0100
3/7,2	16	63	65	192	56	41	13	2.340	1,1	1	67110-0160
3/7,2	20	63	92	192	56	32	14,5	3.900	1,1	1	67110-0200
3/7,2	25	63	110	192	56	25	20	4.900	1,1	1	67110-0250
3/7,2	31,5	63	123	192	56	19	23	7.000	1,1	1	67110-0320
3/7,2	40	63	140	192	56	12,3	30	14.000	1,1	1	67110-0400
3/7,2	50	63	194	192	56	9,3	35	25.300	1,1	1	67110-0500
3/7,2	63	63	220	192	65	8,75	60	41.200	1,4	1	67210-0630
3/7,2	80	63	306	192	65	6,3	85	84.000	1,4	1	67210-0800
3/7,2	100	63	363	192	65	5	96	93.600	1,4	1	67210-1000
3/7,2	125	63	440	192	88	2,9	75	440.000	2,4	1	67110-1250
3/7,2	160	63	509	192	88	2,5	120	500.000	2,4	1	67210-1600
3/7,2	200	63	612	192	88	2,3	200	654.000	2,4	1	67210-2000
6/12	1	63	14	292	56	1500	1,6	90	1,6	1	67220-0010
6/12	2	63	16	292	56	510	2	280	1,6	1	67220-0020
6/12	4	63	22	292	56	338	6	500	1,6	1	67220-0040
6/12	6,3	63	30	292	56	190	8	600	1,6	1	67220-0060
6/12	10	63	42	292	56	139	16	1.150	1,6	1	67220-0100
6/12	16	63	54	292	56	107	38	1.290	1,6	1	67220-0160
6/12	20	63	73	292	56	71	38	3.200	1,6	1	67220-0200
6/12	25	63	93	292	56	52	46	5.200	1,6	1	67220-0250
6/12	31,5	63	105	292	56	43	65	7.200	1,6	1	67220-0320
6/12	40	63	125	292	56	23	54	23.300	1,6	1	67220-0400
6/12	50	63	160	292	56	18	70	34.900	1,6	1	67220-0500
6/12	63	63	230	292	56	12	85	58.300	1,6	1	67220-0630
6/12	80	63	350	292	65	10,6	114	90.000	2,1	1	67220-0800
6/12	100	63	500	292	65	8,5	156	140.000	2,1	1	67220-1000
6/12	125	63	480	292	88	4	117	440.000	3,7	1	67220-1250
6/12	160	63	560	292	88	4,3	217	500.000	3,7	1	67220-1600
6/12	200	63	610	292	88	3,8	333	654.000	3,7	1	67220-2000
6/12	250	63	740	292	88	-	-	-	-	1	67220-2500
10/17,5	2	63	15	367	56	610	4	600	1,9	1	67230-0020
10/17,5	4	63	20	367	56	580	15	800	1,9	1	67230-0040
10/17,5	50	63	165	367	65	28	117	20.600	2,6	1	67230-0500
10/17,5	63	63	220	367	65	21	150	41.200	2,6	1	67230-0630
10/17,5	80	63	300	367	65	15	183	84.000	2,6	1	67230-0800
10/17,5	100	63	350	367	65	13	260	93.600	2,6	1	67230-1000
10/24	1	63	14	442	56	2100	2	90	2,3	1	67240-0010
10/24	2	63	16	442	56	800	3	340	2,3	1	67240-0020
10/24	4	63	23	442	56	550	10	450	2,3	1	67240-0040
10/24	6,3	63	30	442	56	300	13	530	2,3	1	67240-0060
10/24	10	63	43	442	56	220	26	940	2,3	1	67240-0100
10/24	16	63	54	442	56	197	73	1.400	2,3	1	67240-0160
10/24	20	63	73	442	56	134	76	3.100	2,3	1	67240-0200
10/24	25	63	93	442	56	96	89	4.500	2,3	1	67240-0250
10/24	31,5	63	105	442	56	79	127	5.900	2,3	1	67240-0320
10/24	40	63	125	442	56	45	114	18.800	2,3	1	67240-0400
10/24	50	63	205	442	56	35	147	33.500	2,3	1	67240-0500
10/24	63	63	350	442	65	29	163	46.400	3,1	1	67240-0630
10/24	80	63	310	442	65	20,5	233	84.000	3,1	1	67240-0800
10/24	100	63	430	442	78	18	400	93.600	4,1	1	67240-1000
10/24	125	40	760	442	88	11	340	350.000	5,9	1	67240-1250
10/24	160	31,5	900	442	88	9,6	515	500.000	5,9	1	67240-1600
10/24	200	31,5	1050	442	88	7,4	740	730.000	5,9	1	67240-2000

# HV Fuse-Links

Rated voltage range	Rated current	Rated value Maximum breaking current	Rated value Minimum breaking current	Dimensions		Resistance and power dissipation		Operating integral	Weight	PU	Order no.
				e mm	d mm	R <sub>initial</sub> mΩ	P <sub>warm</sub> * W				
U <sub>N</sub> kV	I <sub>N</sub> A	I <sub>1</sub> kA	I <sub>3</sub> A					A2s	kg		
20/36	2	31,5	15	537	56	950	9	600	2,7	1	67250-0020
20/36	4	31,5	20	537	56	900	32	800	2,7	1	67250-0040
20/36	6,3	31,5	23	537	56	827	39	600	2,7	1	67150-0060
20/36	10	31,5	34	537	56	520	65	2.000	2,7	1	67150-0100
20/36	16	31,5	70	537	56	210	67	2.340	2,7	1	67150-0160
20/36	20	31,5	100	537	56	165	84	3.900	2,7	1	67150-0200
20/36	25	31,5	110	537	56	125	100	6.500	2,7	1	67150-0250
20/36	31,5	31,5	135	537	65	85	119	7.000	3,7	1	67150-0320
20/36	40	20	205	537	65	65	176	14.200	3,7	1	67150-0400
20/36	50	20	220	537	88	45	183	40.000	6,5	1	67150-0500
20/36	63	20	360	537	88	35	271	61.700	6,5	1	67150-0630

## HV back-up Fuse-Links acc. to VDE 0670 T4 and T4 ÜLA Time-current characteristics

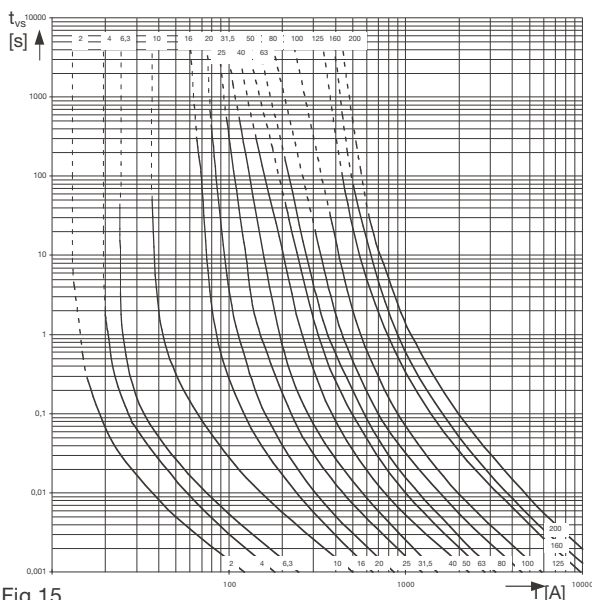

Fig.15  
3/7.2 kV

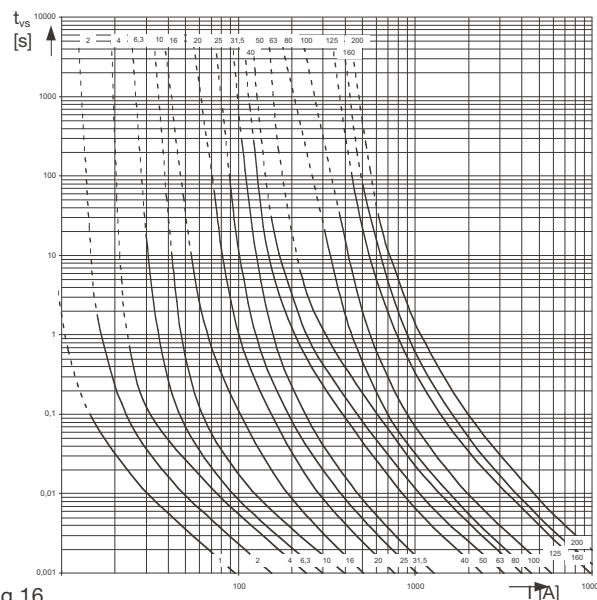

Fig.16  
6/12 kV

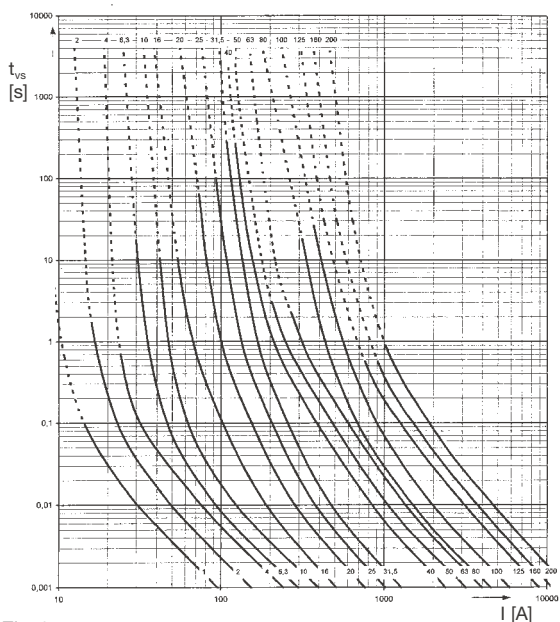

Fig.17  
10/24 kV

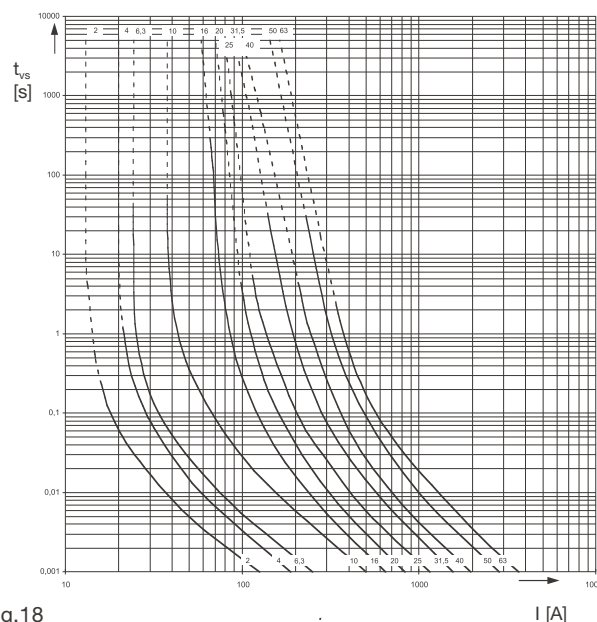

Fig.18  
20/36 kV

# HV Fuse-Links

**EFEN HV back-up Fuse-Links acc. to VDE 0670 T4 / IEC 60 282-1**
**Electrical data, dimensions, weight**

Rated voltage range	Rated current	Rated value Maximum breaking current	Dimensions		Resistance and power dissipation		Operating integral	Weight	PU	Order no.
			e mm	d mm	R <sub>initial</sub> mΩ	P <sub>warm</sub> * W				
U <sub>N</sub> kV	I <sub>N</sub> A	I <sub>1</sub> kA					A2s	kg		
6/12	1	63	442	56	1500	1,5	90	2,3	1	67004-0010
6/12	2	63	442	56	510	2	280	2,3	1	67004-0020
6/12	4	63	442	56	338	6	500	2,3	1	67004-0040
6/12	6,3	63	442	56	190	7	600	2,3	1	67004-060
6/12	10	63	442	56	139	16	1.150	2,3	1	67004-0100
6/12	16	63	442	56	107	36	1.290	2,3	1	67004-0160
6/12	20	63	442	56	71	37	3.200	2,3	1	67004-0200
6/12	25	63	442	56	52	44	5.200	2,3	1	67004-0250
6/12	31,5	63	442	56	43	63	7.200	2,3	1	67004-0320
6/12	40	63	442	56	23	50	23.300	2,3	1	67004-0400
6/12	50	63	442	56	18	60	34.900	2,3	1	67004-0500
6/12	63	63	442	56	12	77	58.300	2,3	1	67004-0630
6/12	80	63	442	65	10,6	101	90.000	3,1	1	67004-0800
6/12	100	63	442	65	8,5	140	140.000	3,1	1	67004-1000
6/12	125	63	442	88	4	100	440.000	5,9	1	67004-1250
6/12	160	63	442	88	4	160	500.000	5,9	1	67004-1600
6/12	200*	63	442	88	3,5	248	654.000	5,9	1	67004-2000

\* Reduction factor 0.95

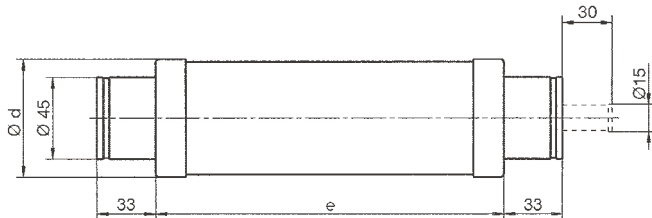
**Dimensions acc. to DIN 43 625 in mm**

# HV Fuse-Links

## EFEN HV general-purpose Fuse-Links

Table 12

### Electrical data, dimensions, weight

Rated voltage range	Rated current	Rated value Maximum breaking current	Dimensions		Resistance and power dissipation		Operating integral	Weight	PU	Order no.
			e mm	d mm	R <sub>initial</sub> mΩ	P <sub>warm</sub> * W				
U <sub>N</sub> kV	I <sub>N</sub> A	I <sub>1</sub> kA					A2s	kg		
6/12	6,3	40	292	65	132	6	2.000	2,3	1	67420-0060
6/12	10	40	292	65	70	8	3.800	2,3	1	67420-0100
6/12	16	40	292	65	35	10	14.000	2,3	1	67420-0160
6/12	25	40	292	65	21	15	36.000	2,3	1	67420-0250
6/12	40	40	292	78	13	24	110.000	3,1	1	67420-0400
6/12	50	40	292	88	10	31	150.000	3,7	1	67420-0500
10/24	4	40	442	78	280	5	1.800	4,1	1	67440-0040
10/24	6,3	40	442	78	260	11	2.000	4,1	1	67440-0060
10/24	10	40	442	78	138	15	3.600	4,1	1	67440-0100
10/24	16	40	442	78	70	21	14.000	4,1	1	67440-0160
10/24	25	40	442	88	41	31	39.000	4,5	1	67440-0250

Time-current characteristics for HV general-purpose Fuse-Links 6/12 kV 6.3 A to 50 A acc. to IEC 60282-1 / VDE 0670 part 4

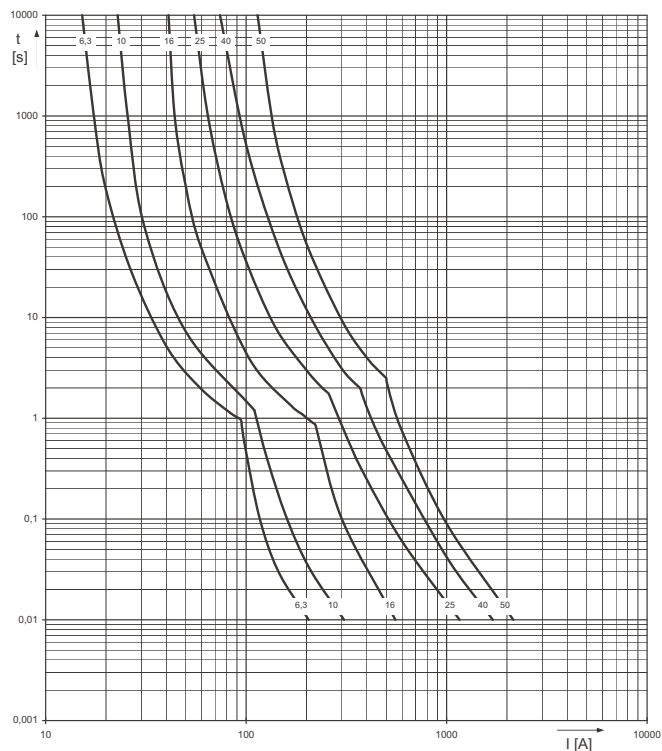

Time-current characteristics for HV general-purpose Fuse-Links 10/24 kV 4 A to 25 A acc. to VDE 0670 part 4

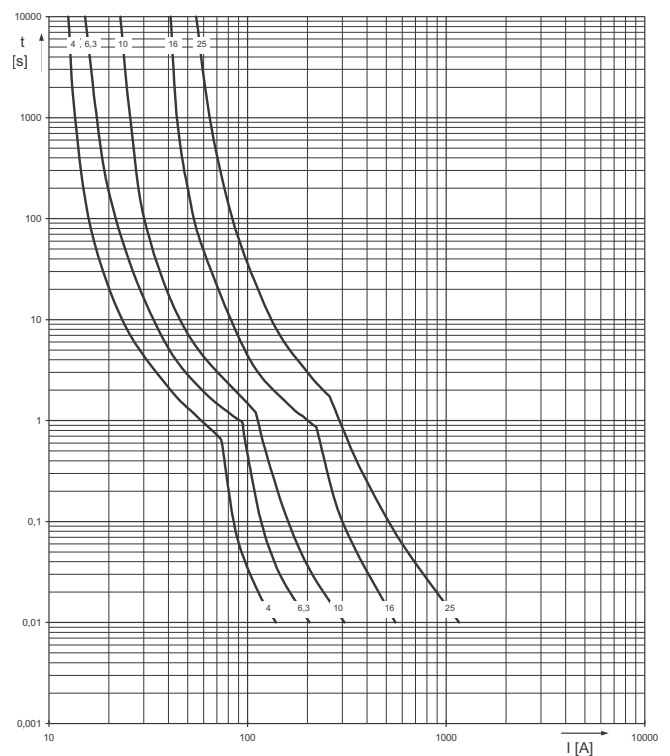

# HV Accessories

Fuse-Links

HV fuse base acc. to DIN 43 624 for indoor use

Electrical data, dimensions, weight

Table 13

Order no.	U <sub>N</sub> kV	I <sub>n</sub> A	Dimensions in mm								Weight in kg	PU
			a	b	c	d	e	f	g	h		
68007-0010	12	200	293	255	195	323	425	55	453	55	3,8	1
68008-0010	24	200	443	335	275	473	575	300	603	66	4,8	1
68012-0010	36	200	538	495	435	568	700	380	698	108	9,4	1
68021-0010	7,2	200	193	254	194	223	325	55	353	55		



Fig. 19  
HV fuse base for indoor use

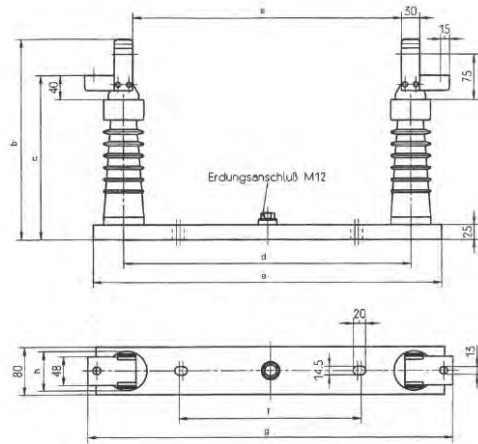
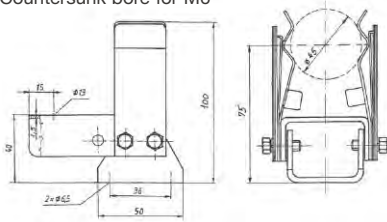

Table 14

Fuse-Base contacts, rated current 200 A

Terminal bolt M10x35  
Countersunk bore for M6



68016-0010

<b>Application</b>	Indoor and outdoor use
<b>Contact spring</b>	E-copper silver-plated
<b>Terminal lug</b>	E-copper tin-plated
<b>Weight</b>	0,42 kg
<b>Order no.</b>	68016-0010

<b>Application</b>	Indoor and outdoor use
<b>Contact spring</b>	E-copper silver-plated
<b>Terminal lug</b>	E-copper tin-plated
<b>Weight</b>	0,35 kg
<b>Order no.</b>	81931-0100

## HV Accessories

**Adapter for high-voltage Fuse-Links acc. to DIN 43 625**  
for extending the fuse-link from dimension "e"  
292 mm (12 kV) to 442 mm (24 kV)

### Adapter

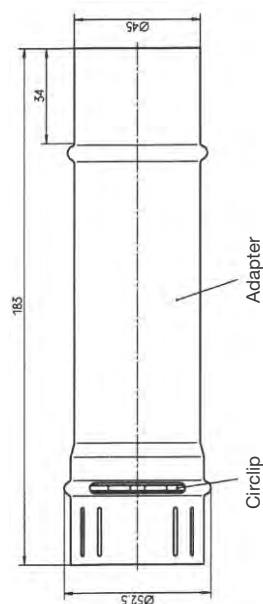

Fig. 20

### Wall rack

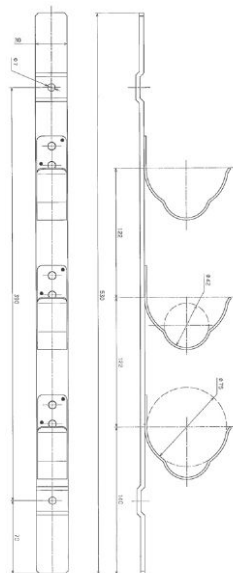

Fig. 21

Designation	Variant	Order no.
Adapter	Surface: silver	68003-0100
Adapter		68003-0200
Wall rack		68004-0010

### Test device for tripping

#### Test device



Fig. 22

#### Extension 12 kV



#### Extension 24 kV



After activation of the timer, the striker is pushed in quickly and the fuse is inserted into the fuse box of the switch to be checked. After approx. 100 s, the switching mechanism trips, knocking out the striker. The dimensions of the test fuse-link correspond to those of HV fuse-links with a rated voltage of 7.2 kV. Extensions are available to adapt the test device to fuse-links of a different voltage.

1. Activate the timer using the yellow pin.
2. Push the striker in quickly.
3. If necessary, put on the adapter.
4. Insert the device into the fuse compartment of the switch and close it.
5. Wait for the device to trip.

#### Safety notice:

**Risk of injury while the timer is running and the striker has not tripped.**

**Stay clear of the tripping area of the test fuse-link.**

**Do not use test fuse-link under voltage.**

Mechanical test fuse-link of type HPS is used to check the tripping of load-break switches. Similar to an HV fuse-link, the test fuse-link consists of a cylindrical fuse body and contains a mechanical tripping mechanism with a timer and striker.

The test fuse-link has been designed for a nominal tripping force of 65 N that is less than the tripping characteristic of the EFEN HV fuse-link. This ensures the reliable tripping of the actual HV fuse-link.

Designation	Dimensions			PU	Order no.
	Diameter in mm	Length in mm	Resulting dimension "e" in mm		
Test device 65 N 192 mm (7.2 kV)	67	190	190	1	68013-0020
Extension to 292 mm (12 kV)	61	100	290	1	68014-0010
Extension to 442 mm (24 kV)	61	250	440	1	68015-0010



## IN THE LINE OF POWER

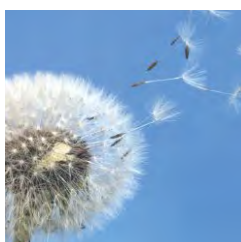

### Efficient Distribution

When it comes to reliable power supply, replacing nuclear power by renewable energies is one of the greatest challenges. To this end, EFEN offers consistent solutions for safety interfaces from power generation to power storage and to the selective control of consumers.



### Reliable Protection

Reliable protection of people and assets is a key requirement of any power distribution system. The comprehensive solutions from EFEN ensure maximum safety in all areas of power supply, infrastructure and industry.



### Smart Control

Higher energy efficiency reduces peak loads and lowers energy costs. Early-warning systems reduce minimal unplanned plant downtimes to the minimum. Smart solutions from EFEN ensure reliable communication and maximum availability of power distribution systems.

**EFEN GmbH**  
Große Hub 10c  
65344 Eltville, Germany  
Tel. + 49 (0) 66123 7045-0  
Fax + 49 (0) 6123 7045-122  
e-Mail: mail@efen.com  
www.efen.com

**Slovakia**  
EFEN Slovakia s.r.o  
Odborárska 3  
831 02 Bratislava  
Slovensko/Slovakia  
Tel. 00421 55 633 9898  
Fax 00421 55 633 9898  
e-Mail: efen@efen.sk

**Logistic - Center**  
EFEN GmbH  
Gewerbepark Nord 6  
04938 Uebigau  
Germany  
Tel. +49 35365 893 0  
Fax +49 35365 893 35  
e-Mail: efen@efen.com

**Hungary**  
EFEN Division  
Guba Sándor u. 87  
7400 Kaposvár  
Hungary  
Tel. +36-82-417559  
Fax +36-82-417529  
e-Mail: info@efen-hungaria.hu

**Austria**  
EFEN GmbH  
Prinzgasse 1/29/9  
1220 Wien  
Austria  
Tel.: +43 (0) 676-9768-100  
Fax: +43 12533033 3366  
e-Mail: suchacek@efen.com

**China**  
EFEN Shanghai Office  
800 Shangchen Rd (1090 New Century Ave)  
Room 517 CIMIC Building Shanghai 200120  
China  
Tel. +86 21 6575-8878  
Fax +86 21 6575-8876  
e-Mail: efen@efen.com.cn

**Poland**  
EFEN sp. z o.o.  
Aleja Młodych 26-28  
41-106 Siemianowice Śląskie  
Poland  
Tel. +48 32 220 00 63  
Fax +48 32 220 00 64  
e-Mail: efen@efen.com.pl  
e-Mail: export@efen.com.pl  
www.efen.com.pl

